

ORDER OUR TOOLING ONLINE!

PRESS BRAKE PRODUCTIVITY CATALOG





 **WILA**
SINCE 1938

INTRODUCTION

The world is ever changing and social trends cannot be seen separately from industrial and commercial trends. Everything is interrelated and that means you must continue to invest and develop in order to keep pace with the latest changes. WILA realizes how important this is and is doing everything necessary to remain at the forefront.

Demand for sustainable solutions with a high level of flexibility continues to increase. And the underlying trend responsible for this - i.e. increasing complexity and decreasing series size, due to ever increasing demand for "customization" and the need to reduce waste - is a major driver for us. Sustainable investment in optimizing the production processes of our customers has become our key business. This applies externally, by offering high quality solutions to our customers, as well as internally, by further optimizing our in-house processes. Once again, everything is interrelated.

WILA offers solutions which must withstand the following questions before they are launched on to the market: does the solution help to further improve customer productivity?; does it allow customers to speed up their production activities?; to produce in a more flexible manner?; to produce in a safer and more reliable manner?; or to produce with greater accuracy so the number of rejects is minimized? All of these factors can result in lower operating costs and higher production efficiency. We want to excel in these specific areas and continue to offer added benefits to our customers.

The only way to achieve this is to subject our in-house processes to the same questions. WILA invests heavily in further optimizing our business activities and production processes, so that we can continue to improve and remain a reliable partner for our customers.

Hans Willemsen
Managing Director.

This catalog features a comprehensive overview of new innovations as well as well-known solutions, and has been compiled in an intuitive and informative manner so it can later be used for reference purposes. We would also like to remind you that this information is also available on our website (www.wilatooling.com) and in our web shop, where you will find our latest news and offerings.

Finally, WILA possesses a team of qualified application engineers and developers who can work with you to design solutions for your specific and special needs. We challenge you to put us to the test!

We would like to thank you for your interest and hope the catalog will enable you to identify new and appealing possibilities to enhance your productivity.



WILA PRESS BRAKE TOOLING SYSTEMS

When productivity is a priority

Modern bending technology is all about productivity. And this priority can only be met with appropriate press brake tools; durable and high quality tools that have been developed to guarantee the productivity you require. For over 90 years, WILA's solutions have been inspired by our mission: Press Brake Productivity.

PRODUCT GROUPS

WILA develops and manufactures tooling systems for press brakes. No two applications are the same and each situation is different. WILA is able to meet all needs via three separate product ranges - New Standard Premium, New Standard Pro and American Style. These lines of products reflect a level of quality that serves as the international standard in press brake tools.

NEW STANDARD PREMIUM

Press brake tools of the very highest quality, which are based on WILA's long standing expertise and experience. They have been developed with great care in order to comply with extreme tolerances and the most complex requirements under all conditions. New Standard Premium is appreciated for its uncompromising performance and quality in sheet metal processing industries throughout the world.

NEW STANDARD PRO

The leading standard for bending applications with less extreme requirements, but where top quality and productivity are essential. New Standard Pro is a comprehensive WILA product line and has been developed for tools with a limited working height. An intelligent combination between clamping system and tooling helps to guarantee perfect and consistent bending results.

AMERICAN STYLE

The WILA product range designed especially for the North American market. American Style press brake tools and accessories have been carefully adapted by WILA to suit the American approach to sheet-metal bending. This range of products is ideal for all press brakes with an American Style upper beam configuration. Of course, WILA's American Style product range is also characterized by very high quality standards.



WILA'S VALUES

Speed, accuracy and safety are core values in all WILA bending technology. Award-winning innovations make the tool changing process faster, safer and extremely accurate. The performance offered by New Standard and American Style tools is of lasting quality. The Universal Press Brake concept guarantees great flexibility, and thereby allows New Standard to realize its full potential throughout the world. Together, the following WILA values help to create a solid foundation for all of our products.

ACCURACY

Perfectionism is an essential element of productivity. All WILA's New Standard and American Style tools and accessories have a modular structure and have been created with the highest level of precision. This guarantees you the exact tolerances you require. The combination of New Standard and American Style tools with New Standard Tool Holders (Clamping, Crowning and Bottom Tool Holders) offers the most refined configuration possibilities for permanently eliminating horizontal and vertical tolerances.

DURABILITY

All WILA products have a long life span. New Standard tools are CNC-Deeaphardened® (56-60 HRc) for all bending radii and are extremely wear resistant. Many New Standard Tool Holders systems (Clamping, Crowning and Bottom Tool Holders) are also CNC-Deeaphardened® (ca. 56 HRc) throughout the critical tool loading slot and are manufactured from high quality CR-MO steel to avoid load compression. This high level performance is guaranteed over a long life span, with wear and tear becoming a negligible concern.

FLEXIBILITY

It is important to create an effective balance between press brakes, tools and the operator if one wants to achieve a high level of productivity. And this productivity must be available to all users because WILA respects a customer's right to use different types and brands of machines. The Universal Press Brake concept makes it possible to use this high quality bending technology with every type of press brake. This means all press brakes can be suitable for New Standard, American Style as well as customized tools.

SPEED

Even the very best press brakes are less productive without efficient tool changes. WILA's award-winning technology makes it possible to change all top and bottom tools very quickly. Heavier tools can also be changed in no time at all. And this is done while respecting high standards of efficiency, ergonomics and safety.

SAFETY

Productivity is the result of cutting edge technology, but also involves human intervention. That is why WILA takes no risks when it comes to creating safe working environments. Constant and explicit attention to safety has helped to create groundbreaking innovations. For example, New Standard and American Style top tools feature the patented Safety-Click® system and all tools are segmented to allow easy one operator handling.

PRODUCT INDEX

INTRODUCTION	3
WILA PRESS BRAKE TOOLING SYSTEMS	4
WILA'S VALUES	5
TOOL HOLDERS	8
FACT SHEET	9-11
NEW STANDARD PREMIUM	12
NEW STANDARD PRO	18
AMERICAN STYLE	32
STANDARD UPB LENGTH	36
MAXIMUM TOOL WEIGHT	37
CUSTOM STYLE CROWNING	38
TOOLING	40
FACT SHEET	41-43
NEW STANDARD PREMIUM	45
NEW STANDARD PRO	71
CUSTOM STYLE	76
ADJUSTABLE BOTTOM TOOLS (MVM AND MULTI-V)	77
FLATTENING TOOLS	80
FLATTENING TOOLS (DD)	84
NEW STANDARD PREMIUM	84
NEW STANDARD PRO	86
TOOL EXTENDERS/TOOLING	88
NEW STANDARD PRO	90
CUSTOM STYLE	101
COMPONENTS	102
HYDRAULIC POWER PACKS	103
PRESS BRAKE PRODUCTIVITY CABINETS	104
GRIPPER	106
NON-MARKING ACCESSORIES	108
CLAMPING SYSTEMS	109
ALL SORTS OF INFORMATION	110
AIR BENDING TONNAGE CHART	110
TONNAGE CHART FOR FLATTENING	111
INDUSTRY 4.0: FROM PRODUCT TO PROCESS	112
CNC-DEEPHARDENING® VERSUS	114
NITRIDE TERMS	115



WILA
INDUSTRIAL
MACHINERY

NEW STANDARD TOOL HOLDERS

The perfect match with your tools

WILA's state-of-the-art Clamping and Crowning systems offer the ultimate solution when it comes to efficiently changing tools, whether hydraulic, mechanical or pneumatic. Several innovations, like the Safety-Click[®], the Smart Tool Locator[®] and the E2M[®] changing system for (heavy) tools, have made the changeover process easier and safer. Accuracy and ergonomics have been coordinated to realize the highest level of productivity. WILA's Tool Holder program has been divided into several product ranges: New Standard Premium, New Standard Pro and American Style.

TOOL HOLDERS

TOOL HOLDERS

FACT SHEET TOOL HOLDERS												
New Standard Premium Clamping	New Standard HD Premium Clamping	New Standard Premium Crowning	New Standard HD Premium Crowning	New Standard Premium Bottom Tool Holder	New Standard HD Premium Bottom Tool Holder	New Standard Pro Clamping	New Standard Pro Crowning	New Standard HD Pro Crowning	New Standard Pro Bottom Tool Holder	New Standard HD Pro Bottom Tool Holder	American Style Clamping	

Accuracy

Working surface precision	+++	+++	+++	+++	+++	+++	++	++	++	++	++	++
Tx-alignment	●	●	●	●	●	●	●	●	●	●	●	●
Ty-alignment	-	-	●	○ (W = 158 mm)	○	○	○	●	○ (W = 158 mm)	○	○	○

Durability

High tensile CrMo steel alloy, $\geq 1000 \text{ N/mm}^2$	●	●	●	●	●	●	-	-	-	-	-	●
High quality tool steel, 600-720 N/mm ²	-	-	-	-	-	-	●	●	●	●	●	-
Pressure surface CNC-Deephardened® to approx. 56°, HRC.	●	●	●	●	●	●	-	-	-	-	-	-
Max. load	Head load	200 ² /250 t/m	250 t/m	-	-	-	180 t/m	-	-	-	-	-
	Shoulder load	200 ² /300 t/m	800 t/m	300 t/m	800 t/m	200 ² /300 t/m	800 t/m	250 t/m	200 t/m	500 t/m	200 t/m	500 t/m

Flexibility

Easy reversibility of tooling because of symmetrical adaption	●	●	●	●	●	●	●	●	●	●	●	●	
Hydraulic Clamping (max. 50 bar oil pressure, power pack available ¹⁾)	●	●	●	●	●	●	●	●	●	●	●	●	
Manual Clamping	○	-	○	-	○	-	○	○	○	○	○	○	
Pneumatic Clamping ($\geq 7 \text{ bar}$) L = $\leq 4250 \text{ mm}$	○	-	-	-	○	-	○	○	-	○	-	-	
Individual Clamping of each tool segment, as of	Hydr./Pneum. Clamping	10 mm	40 mm	10 mm	40 mm	10 mm	40 mm	15 mm	15 mm	40 mm	15 mm	40 mm	15 mm
	Man. Clamping	20 mm	-	20 mm	-	20 mm	-	20 mm	20 mm	40 mm	20 mm	40 mm	20 mm
Designed for use on new press brakes equipped with UPB hole pattern ¹⁾	●	●	●	●	●	●	●	●	●	●	●	●	
Available for press brakes not equipped with UPB hole pattern	-	-	-	-	○	-	○	○	-	○	-	○	
ATC possible (Gripper, TIPS®)	○	-	○	-	○	-	-	-	-	-	-	-	
Smart Tool Locator®	○	○	○	○	-	○	○	○	○	○	○	○	
Vertical* + horizontal loading *Safety-Clicks® required with top tools	●	●	-	-	-	-	●	-	-	-	-	●	
Max tool weight (top tools: self seating)	Hydr. Clamping	300 kg/m	1000 kg/m				100 kg/m					75 kg/m	
	Man. Clamping	180 kg/m					180 kg/m						
	Pneum. Clamping	100 kg/m					70 kg/m						

Speed

Automatic clamping seating and aligning of the tooling	●	●	●	●	●	●	●	●	●	●	●	● ⁴⁾
Fast tool changing	●	●	●	●	●	●	●	●	●	●	●	●
Equipped for E2M®	●	●	●	●	●	●	●	●	●	●	●	-
Crowning adjustment (Standard on the right side)	CNC	-	-	● <2500 kg	○ <4000 kg	-	-	● <2500 kg	X >4000 kg	-	-	-
	Hydr	-	-	● >2500 kg	○ >4000 kg	-	-	● >2500 kg	X >4000 kg	-	-	-
	H	-	-	● <1500 kg	-	-	-	● <1500 kg	-	-	-	-
	HF (L $\leq 4300 \text{ mm}$)	-	-	≈75-100 kg/m	-	-	-	≈75-100 kg/m	-	-	-	-

Safety

Equipped for use of Safety-Clicks® up to 12,5 kg	●	●	-	-	-	-	●	-	-	-	-	●
Equipped for use of Safety-Pins > 12,5 kg	●	●	-	-	-	-	●	-	-	-	-	●
Clamping equipped with V-Lock®	-	-	●	●	●	●	-	●	-	●	-	-
Pillars for supporting wide bottom tools	-	-	-	○	-	○	-	-	○	-	○	-

Guards

Hardened steel	●	●	●	●	●	●	-	-	-	-	-	-
Plastic	-	-	-	-	-	-	●	●	●	●	●	●
E2M® with roll-out safety device (Hardened steel)	○	●	○	●	○	●	○	○	●	○	●	-

● - Standard ○ - Optional - - Not available ¹⁾ Various UPB hole patterns are used, for more information please contact WILA. ²⁾ Pneumatic Clamping. ³⁾ See page 103. ⁴⁾ Hydraulic Clamping.

NSCL-I New Standard Pro Clamping non-hardened version	NSCR-I New Standard Pro Crowning non-hardened version	HC Hydraulic Clamping. Used in Clamping, Crowning and Bottom Tool Holders
ASCL-I American Style Clamping non-hardened version	OB-I New Standard Pro Bottom Tool Holder non-hardened version	MC Mechanical Clamping. Used in Clamping, Crowning and Bottom Tool Holders
NSCL-II New Standard Premium Clamping hardened version	NSCR-II New Standard Premium Crowning hardened version	HD Heavy Duty
	OB-II New Standard Premium Bottom Tool Holder hardened version	SL Pneumatic Clamping. Used in Clamping, Crowning and Bottom Tool Holders

TOOL HOLDERS for every press brake

Mounting possibilities top and bottom tools

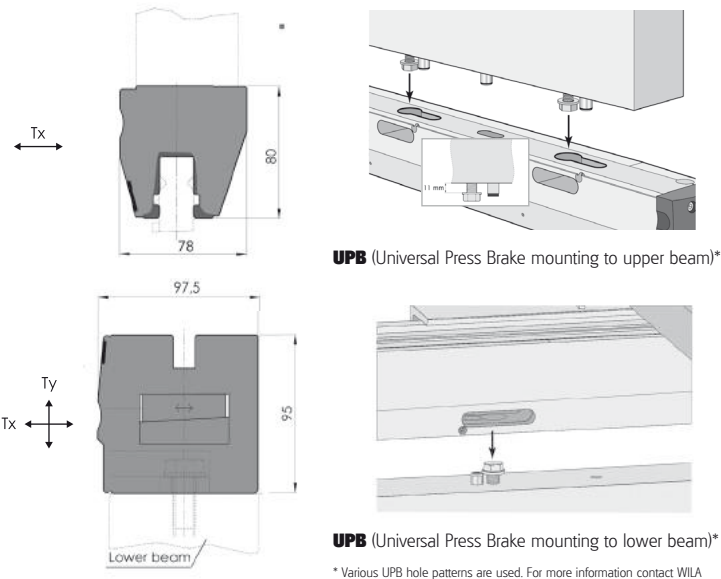

UPB (Universal Press Brake mounting to upper beam)*

UPB (Universal Press Brake mounting to lower beam)*

* Various UPB hole patterns are used. For more information contact WILA

Examples of retrofit mounting solutions (top and bottom) for existing press brakes, other adaptions available.

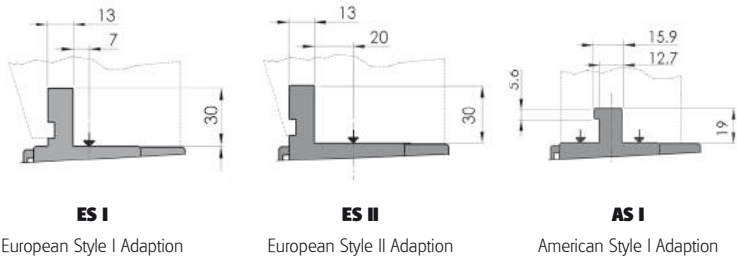

ES I
European Style I Adaption

ES II
European Style II Adaption

AS I
American Style I Adaption

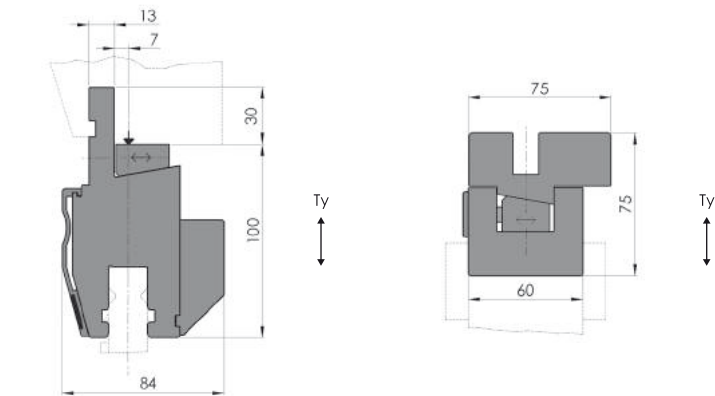

Example: Tool Holder with ES I adaption including Ty-alignment

Example: Tool Holder with ES IV adaption including Ty-alignment

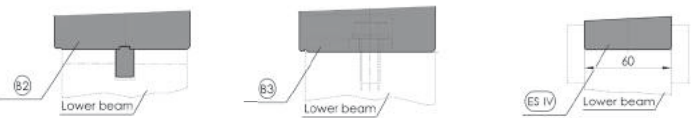

Adaption B2
For tang mounting to the slot in the lower beam

Adaption B3
For mounting to the lower beam to existing bolt hole pattern

ES IV
European Style IV 60 mm wide adaption

To suit New Standard top tools with NS I or II adaption, respectively American Style with AS I or II adaption.

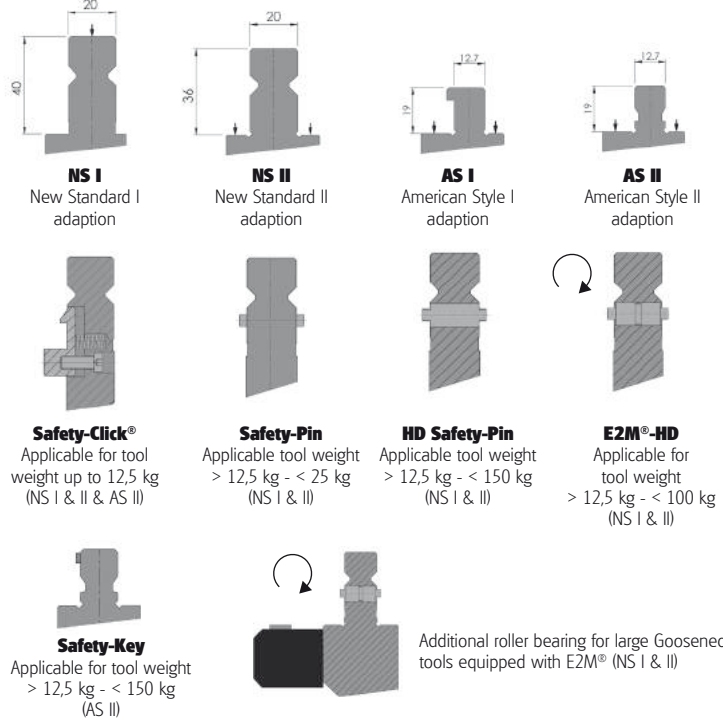

NS I
New Standard I adaption

NS II
New Standard II adaption

AS I
American Style I adaption

AS II
American Style II adaption

Safety-Click®
Applicable for tool weight up to 12,5 kg (NS I & II & AS II)

Safety-Pin
Applicable tool weight > 12,5 kg - < 25 kg (NS I & II)

HD Safety-Pin
Applicable tool weight > 12,5 kg - < 150 kg (NS I & II)

E2M®-HD
Applicable for tool weight > 12,5 kg - < 100 kg (NS I & II)

Safety-Key
Applicable for tool weight > 12,5 kg - < 150 kg (AS II)

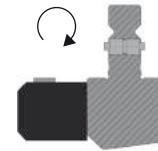

Additional roller bearing for large Gooseneck tools equipped with E2M® (NS I & II)

To suit New Standard and American Style bottom tools with NS V or NS VI adaption

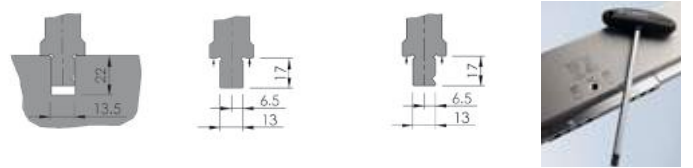

Tool slot to suit for NS V and NS VI adaption

NS V
New Standard V adaption

NS VI
New Standard VI adaption with V-Lock®

E2M®
For bottom tools weight > 12,5 kg

Crowning centralized adjustment

CNC
Motorized at the end of Crowning
CRM 14 (Premium)



H
Manual at the end of Crowning



CRM 7 (Pro)



Hf
Manual in the front of Crowning



CRM 12 (Premium & Pro)



CRM 30 (HD)



Hy
Hydraulic at the end. Only in case of HD crowning with tool weight more than 4000 kg

A All New Standard and American Style Tool Holders are equipped with Guards. E2M® Guards come with roll-out prevention device.

B Tool Holders suitable for New Standard or American Style top tools provided with; Safety-Click®, Safety-Pin or E2M®. (E2M® with NS, Safety-Pin with AS only)

C Tool Holders suitable for 'Head' and 'Shoulder' load top tools.

D Clamps tool segments from 10 mm in length.

E Horizontal and Vertical loading of Tooling.



Top Tool Holders available with Hydraulic Clamping (HC), Pneumatic Clamping (SL) or Manual Clamping (MC).

Tx

Tool alignment in X-direction (in relation to the back gauge), ideally incorporated in every Tool Holder.

Ty

Tool alignment in Y-direction to compensate for unavoidable accumulated machining tolerances, to be incorporated in Tool Holders.

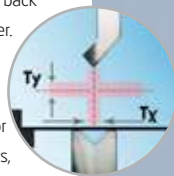

F Tool Holders suitable for 'Shoulder' load New Standard and American Style bottom tools with NS V and VI adaption.

G New Standard and American Style Tool Holders are available with Smart Tool Locator® (STL).

H Ty-alignment with localized adjustment dials.

Bottom Tool Holders available with Hydraulic Clamping (HC), Pneumatic Clamping (SL) or Manual Clamping (MC).

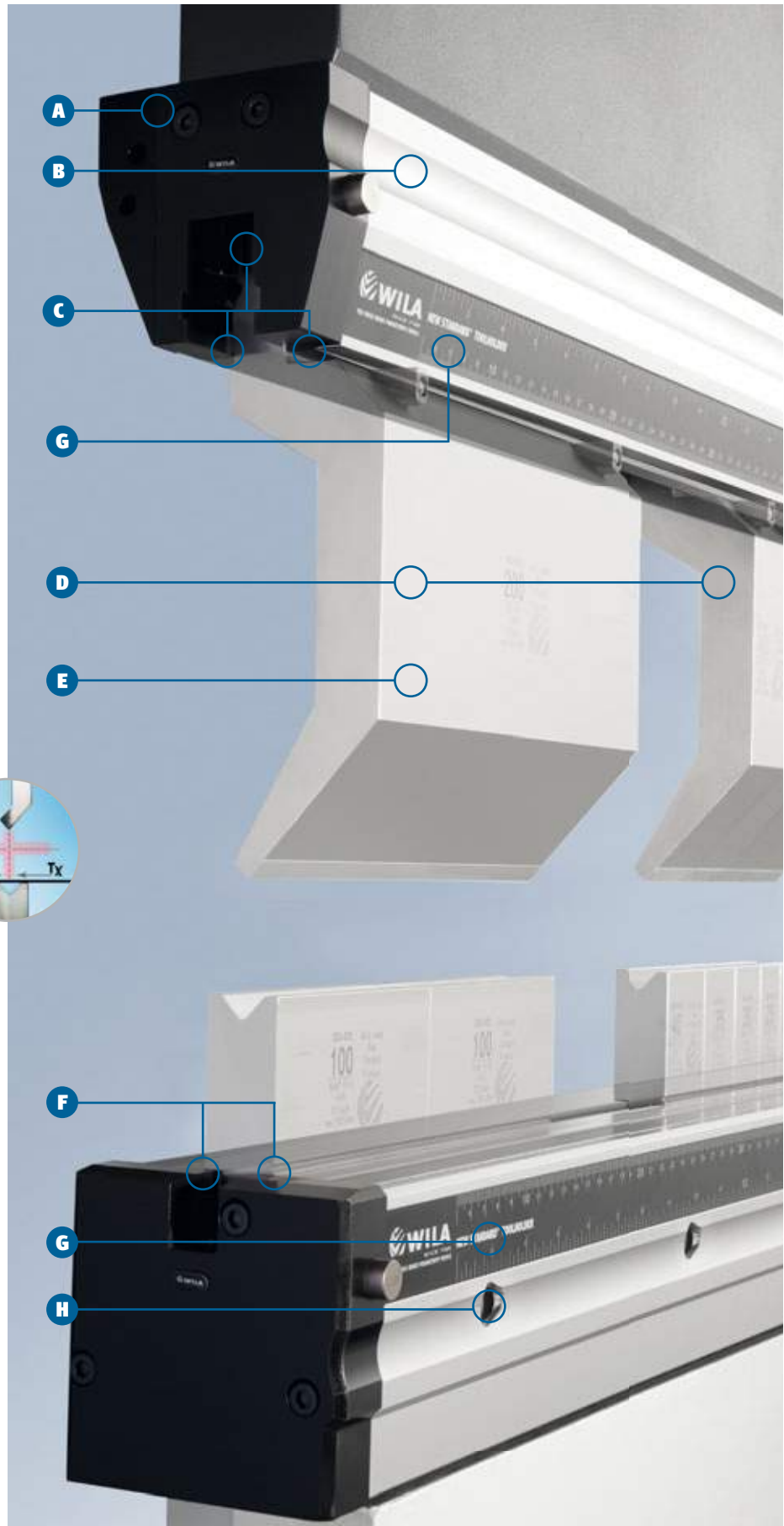

NSCL-II-HC/UPB

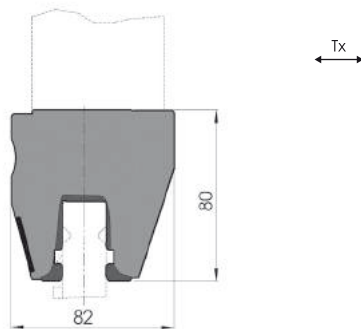

NSCL-HD-II-HC/UPB

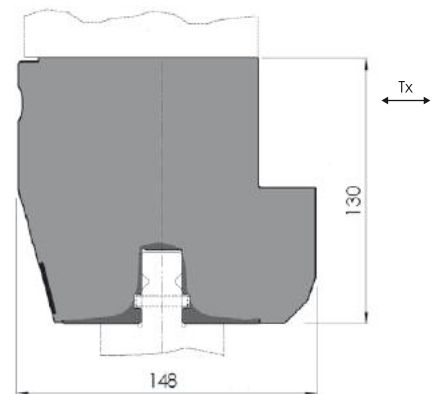

	Standard	Optional
Tool slot CNC-Dee hardened®	●	
Hydraulic Clamping	●	
Manual Clamping		○
Designed for press brakes with UPB-II hole pattern	●	
Cover strip with scale	●	
Tx-alignment	●	
Smart Tool Locator® (STL)*		○
Guards	●	
Weight		32 kg/m
Max. load head/shoulders		250/300 t/m

	Standard	Optional
Tool slot CNC-Dee hardened®	●	
Hydraulic Clamping	●	
Designed for press brakes with UPB-IV hole pattern	●	
Cover strip with scale	●	
Tx-alignment	●	
Smart Tool Locator® (STL)*		○
E2M® Guards	●	
Weight		116 kg/m
Max. load head/shoulders		250/800 t/m

* Not available for Tool Holders with Manual Clamping.

ADAPTION

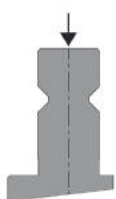

NS I head load

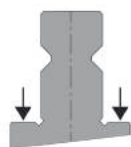

NS II shoulder load

SMART TOOL LOCATOR® (STL)



This intelligent ruler equipped with LED lighting immediately shows where tools must be placed in the Tool Holder. The Smart Tool Locator® also identifies the exact bending sequence.

NSCR-II-HC-CNC/UPB

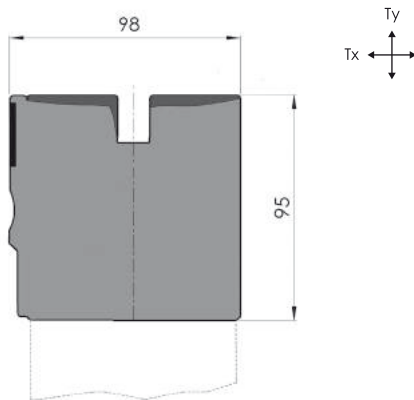

	Standard	Optional
Tool slot CNC-Deepphardened®	●	
Hydraulic Clamping	●	
Manual Clamping		○
Designed for press brakes with UPB-II hole pattern	●	
Cover strip with scale	●	
Tx-alignment	●	
Ty-alignment permanently accessible	●	
Ty-alignment behind Cover strip		○
Smart Tool Locator® (STL)*		○
Guard	●	
Drive unit CNC, Motor at one end	●	
Drive unit CNC, Motor completely built-in		○
Weight		66 kg/m
Max. load shoulders		300 t/m

* Not available for Tool Holders with Manual Clamping.

ADAPTION

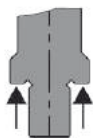

NS V shoulder load

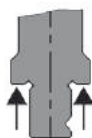

**NS VI shoulder load
with V-Lock®**

V-LOCK®



The V-Lock® improves the clamping and positioning of bottom tools. A groove in the tool tang allows specially designed clamping pins to automatically align and firmly clamp bottom tools in both X and Y directions.

All newly manufactured New Standard Crowning and Bottom Tool Holders with Hydraulic Clamping will be supplied with specially designed clamping pins to take advantage of the V-Lock® feature.

NSCL-II-SL/UPB



OB-II-SL/UPB

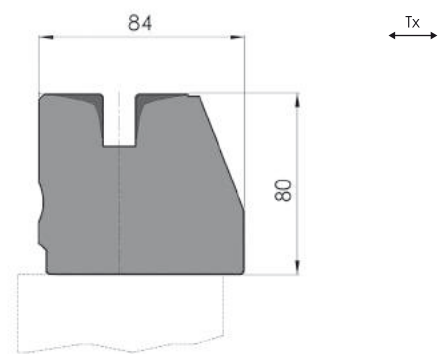
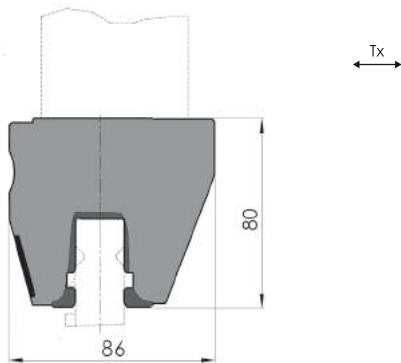

	Standard	Optional
Tool slot CNC-Dee hardened®	●	
Pneumatic Clamping	●	
Designed for press brakes with UPB-VIII hole pattern	●	
Cover strip with scale	●	
Tx-alignment	●	
Smart Tool Locator® (STL)		○
Guards	●	
Weight		33 kg/m
Max. load head/shoulders		200 t/m

	Standard	Optional
Tool slot CNC-Dee hardened®	●	
Pneumatic Clamping	●	
Designed for press brakes with UPB-VIII hole pattern	●	
B2 or B3 mounting		○
Cover strip with scale	●	
Tx-alignment	●	
Smart Tool Locator® (STL)		○
Guards	●	
Weight		30 kg/m
Max. load shoulders		200 t/m

ADAPTION



NS I head load

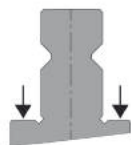

NS II shoulder load

SELF-LOCKING



Tools are clamped using a pneumatically-controlled pair of self-adjusting wedges. When the wedges are engaged (clamped), they become an integral part of the tool. The Self-Locking® principle is suitable for clamping WILA's New Standard top and bottom tools (BIU and OZU). The Premium clamping is also released pneumatically.

NSCR-HD-II-HC-150-CNC/UPB

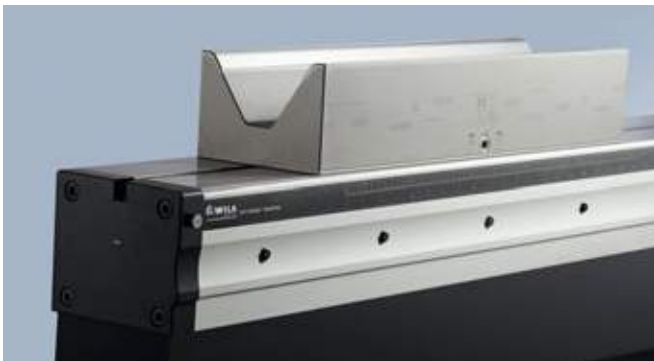

NSCR-HD-II-HC-250-CNC/UPB

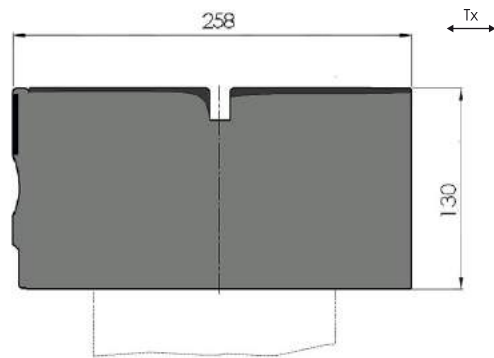
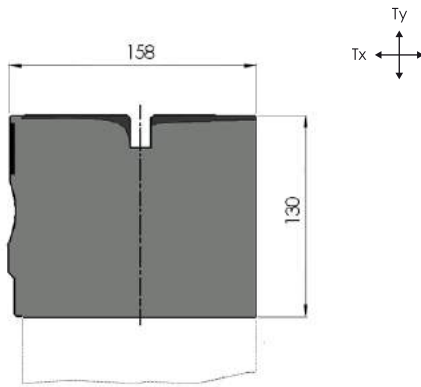

	Standard	Optional
Tool slot CNC-Deepphardened®	●	
Hydraulic Clamping	●	
Designed for press brakes with UPB-VI hole pattern	●	
B2 mounting to the lower beam instead of UPB		○
Cover strip with scale	●	
Tx-alignment	●	
Ty-alignment permanently accessible	●	
Ty-alignment behind Cover strip		○
Smart Tool Locator® (STL)		○
E2M® Guards	●	
Drive unit CNC, Motor (max. tool weight 4000 kg)	●	
Drive unit CNC, Hydraulic (tool weight > 4000 kg)		○
Weight		154 kg/m
Pillars for supporting extra wide bottom tools		○
Max. load shoulders		800 t/m

	Standard	Optional
Tool slot CNC-Deepphardened®	●	
Hydraulic Clamping	●	
Designed for press brakes with UPB-VII hole pattern	●	
B2 mounting to the lower beam instead of UPB		○
Cover strip with scale	●	
Tx-alignment	●	
Smart Tool Locator® (STL)		○
E2M® Guards	●	
Drive unit CNC, Motor (max. tool weight 4000 kg)	●	
Drive unit CNC, Hydraulic (tool weight > 4000 kg)		○
Weight		258 kg/m
Pillars for supporting extra wide bottom tools		○
Max. load shoulders		800 t/m

ADAPTION

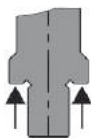

NS V shoulder load

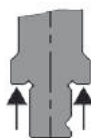

NS VI shoulder load with V-Lock®

PILLAR



When using "HD" Tool Holders, it is possible to install 'pillars' to further support very wide and heavy bottom tools. These pillars offer additional stability to tools during the bending process. Available every 255 mm on front and backside.

OB-II-HC-TY/UPB



OB-II-HC/UPB

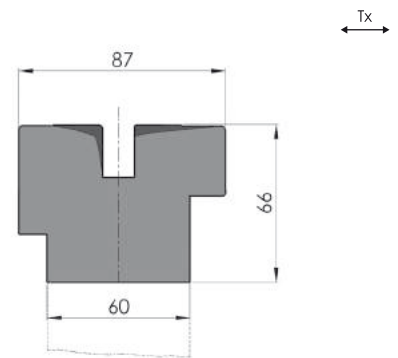
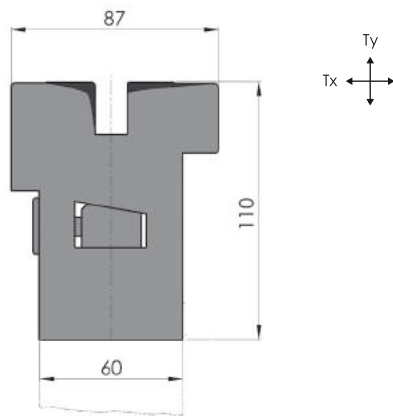

	Standard	Optional
Tool slot CNC-Deeplhardened®	●	
Hydraulic Clamping	●	
Manual Clamping		○
Designed for press brakes with UPB-II hole pattern	●	
ES IV, B2 or B3 mounting**		○
Tx-alignment	●	
Ty-alignment permanently accessible	●	
Weight		57 kg/m
Max. load shoulders		300 t/m

	Standard	Optional
Tool slot CNC-Deeplhardened®	●	
Hydraulic Clamping	●	
Manual Clamping		○
Designed for press brakes with UPB-II hole pattern	●	
ES IV, B2 or B3 mounting**		○
Tx-alignment	●	
Weight		37 kg/m
Max. load shoulders		300 t/m

** Height may change.

ADAPTION

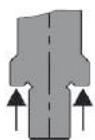

NS V shoulder load

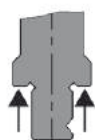

NS VI shoulder load with V-Lock®

TY-ADJUSTMENT



Ty-adjustment is crucial in achieving parallelism between top and bottom tools. Adjustment in Y direction makes it possible to fully compensate for unavoidable - cumulative - machining tolerances in the press brake. Either the top or bottom Tool Holder must be able to do this if one wants to achieve accurate and consistent bending results.

OB-HD-II-HC-TY/UPB

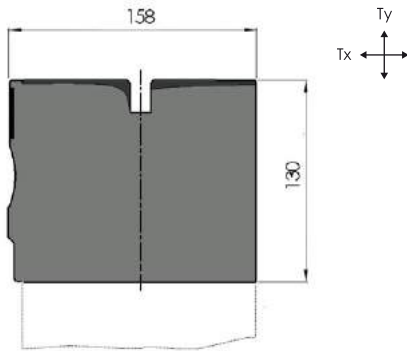

OB-HD-II-HC/UPB

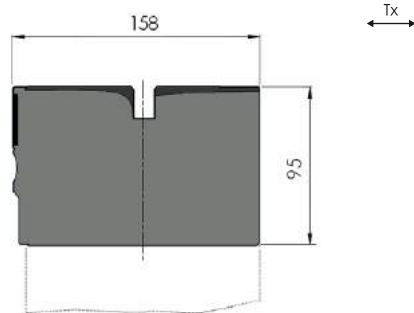

	Standard	Optional
Tool slot CNC-DeePhardened®	●	
Hydraulic Clamping	●	
Designed for press brakes with UPB-VI hole pattern	●	
B2 mounting to the lower beam instead of UPB		○
Cover strip with scale	●	
Tx-alignment	●	
Ty-alignment permanently accessible	●	
Ty-alignment behind Cover strip		○
Smart Tool Locator® (STL)		○
E2M® Guards	●	
Weight		154 kg/m
Pillars for supporting extra wide bottom tools		○
Max. load shoulders		800 t/m

	Standard	Optional
Tool slot CNC-DeePhardened®	●	
Hydraulic Clamping	●	
Designed for press brakes with UPB-VI hole pattern	●	
B2 mounting to the lower beam instead of UPB		○
Cover strip with scale	●	
Tx-alignment	●	
Smart Tool Locator® (STL)		○
E2M® Guards	●	
Weight		112 kg/m
Pillars for supporting extra wide bottom tools		○
Max. load shoulders		800 t/m

ADAPTION

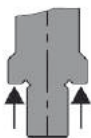

NS V shoulder load

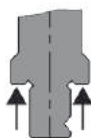

NS VI shoulder load with V-Lock®

CNC-DEEPHARDENING®



Almost all press brake tools produced by WILA are CNC-DeePhardened®. The same applies to WILA's New Standard Premium Tool Holders. This makes them extremely robust and durable. Our New Standard Premium Tool Holders are hardened as shown here.

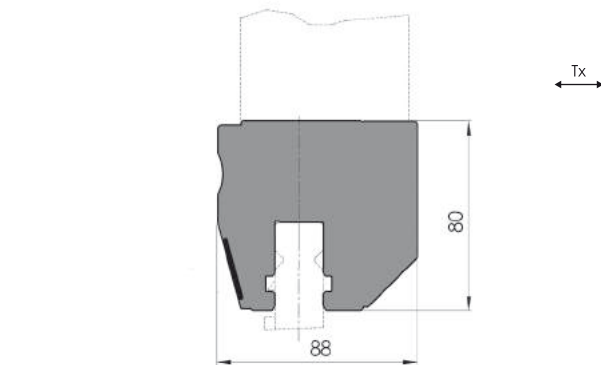

	Standard	Optional
Hydraulic Clamping	●	
Manual Clamping		○
Designed for press brakes with UPB-II hole pattern	●	
Cover strip with scale	●	
Tx-alignment	●	
Smart Tool Locator® (STL)*		○
Guards	●	
Weight	32 kg/m	
Max. load head/shoulders	180/250 t/m	

* Not available for Tool Holders with Manual Clamping.

ADAPTION



NS I head load

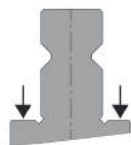

NS II shoulder load

TX-ADJUSTMENT

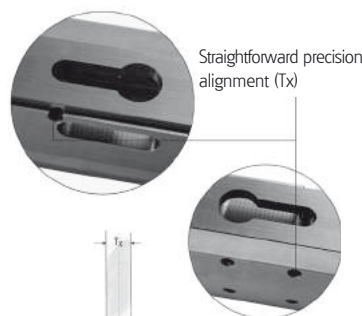

Tx-adjustment is needed to configure the position of the bending line (centerline of tools) in relation to the back gauge of the press brake, to an extremely high level of precision. Ideally, all Tool Holders should feature this capability.

NSCL-I-HC-TY/ES I

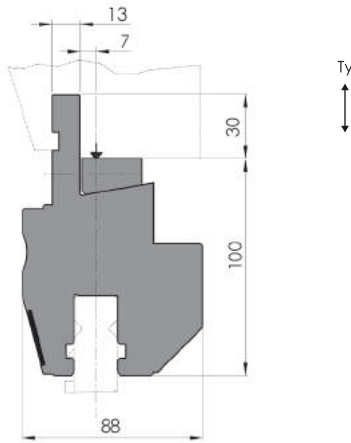

NSCL-I-HC/ES I

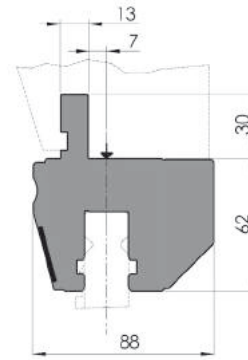

	Standard	Optional
Hydraulic Clamping	●	
Manual Clamping		○
Designed for press brakes with European Style I upper beam	●	
Cover strip with scale	●	
Ty-alignment	●	
Smart Tool Locator® (STL)*		○
Guards	●	
Weight		46 kg/m
Max. load head/shoulders		180/250 t/m

	Standard	Optional
Hydraulic Clamping	●	
Manual Clamping		○
Designed for press brakes with European Style I upper beam	●	
Available to suit any existing ram-style		○
Cover strip with scale	●	
Smart Tool Locator® (STL)*		○
Guards	●	
Weight		26 kg/m
Max. load head/shoulders		180/250 t/m

* Not available for Tool Holders with Manual Clamping.

ADAPTION



NS I head load

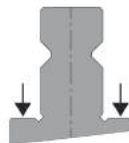

NS II shoulder load

GUARD FOR E2M®



Special Guards are available for WILA's E2M® system. These Guards feature an E2M® locking device, which means tools cannot be removed by the clamp until the operator releases them.

NSCL-I-HC-TY/ES II

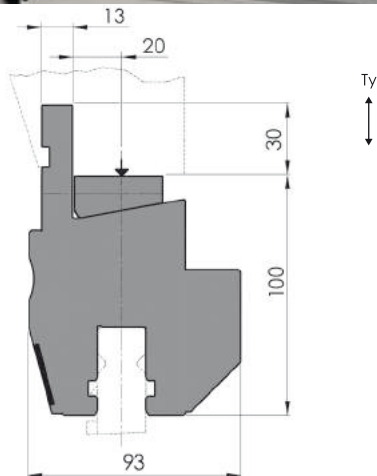

	Standard	Optional
Hydraulic Clamping	●	
Manual Clamping		○
Designed for press brakes with European Style II upper beam	●	
Cover strip with scale	●	
Ty-alignment	●	
Smart Tool Locator® (STL)*		○
Guards	●	
Weight	48 kg/m	
Max. load head/shoulders	180/250 t/m	

NSCL-I-HC/ES II

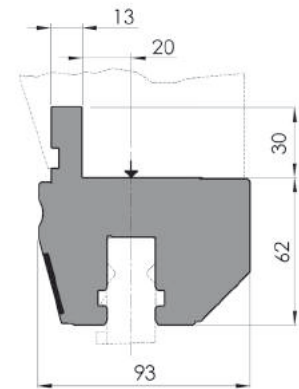

	Standard	Optional
Hydraulic Clamping	●	
Manual Clamping		○
Designed for press brakes with European Style II upper beam	●	
Available to suit any existing ram-style		○
Cover strip with scale	●	
Smart Tool Locator® (STL)*		○
Guards	●	
Weight	28 kg/m	
Max. load head/shoulders	180/250 t/m	

* Not available for Tool Holders with Manual Clamping.

ADAPTION



NS I head load

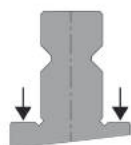

NS II shoulder load

GUARDS



Guards are cover plates for the ends of the Tool Holders that make it easier to insert tools horizontally. In addition, Guards protect clamps and tools against damage.

NSCL-I-HC/AS I

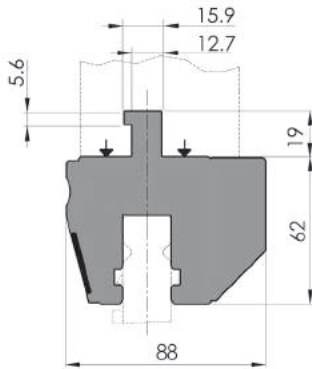

NSCL-I-HC/11766

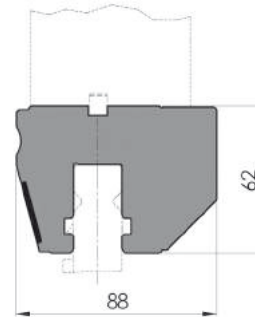

	Standard	Optional
Hydraulic Clamping	●	
Manual Clamping		○
Designed for press brakes with American Style I upper beam	●	
Available to suit any existing ram-style		○
Cover strip with scale	●	
Smart Tool Locator® (STL)*		○
Guards	●	
Weight		26 kg/m
Max. load head/shoulders		180/250 t/m

	Standard	Optional
Hydraulic Clamping	●	
Manual Clamping		○
Designed as replacement for press brakes equipped with ModuFix clamping system	●	
Cover strip with scale	●	
Smart Tool Locator® (STL)*		○
Guards	●	
Weight		24 kg/m
Max. load head/shoulders		180/250 t/m

* Not available for Tool Holders with Manual Clamping.

ADAPTION



NS I head load

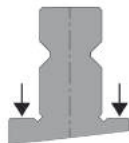

NS II shoulder load

MODUFIX CLAMPING SYSTEM



The current New Standard Tool Holder Clamping models can be seen as the successor to the ModuFix Clamping System, which was first introduced in 1990. For a possible replacement of this model, we offer you the NSCL-I-HC / 11766.



TOOL HOLDERS
NEW STANDARD PRO

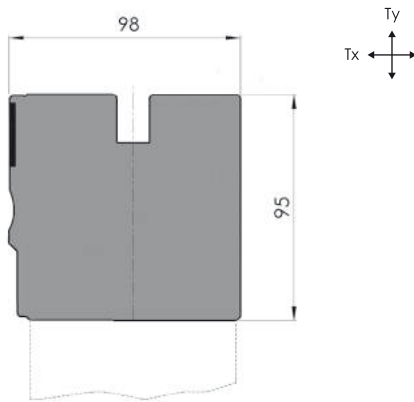

	Standard	Optional
Hydraulic Clamping	●	
Manual Clamping		○
Designed for press brakes with UPB-II hole pattern	●	
B2 or B3 mounting		○
Cover strip with scale	●	
Tx-alignment	●	
Ty-alignment permanently accessible		○
Ty-alignment behind Cover strip	●	
Smart Tool Locator® (STL)*		○
Guard	●	
Drive unit CNC, Motor at one end	●	
Drive unit H, Hand crank assembly at one end		○
Drive unit Hf, manually in the front		○
Weight		66 kg/m
Max. load shoulders		200 t/m

* Not available for Tool Holders with Manual Clamping.

ADAPTION

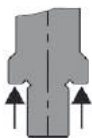

NS V shoulder load

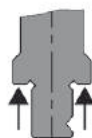

NS VI shoulder load
with V-Lock®

CRM7 CNC DRIVE MOTOR



CRM7 is a CNC-driven drive motor which has been designed for New Standard Pro Crowning. This motor makes it possible to horizontally insert and remove bottom tools from both ends. The CRM7 motor is available for crowning lengths up to 4300 mm.

NSCR-HD-I-HC-150-CNC/UPB

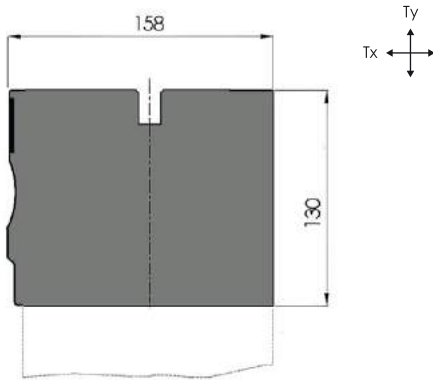

NSCR-HD-I-HC-250-CNC/UPB

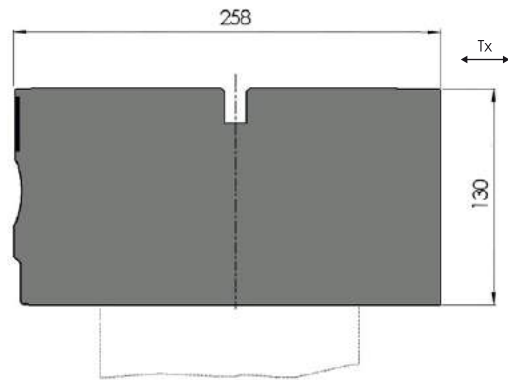

	Standard	Optional
Hydraulic Clamping	●	
Manual Clamping		○
Designed for press brakes with UPB-VI hole pattern	●	
B2 mounting to the lower beam instead of UPB		○
Cover strip with scale	●	
Tx-alignment	●	
Ty-alignment permanently accessible		○
Ty-alignment behind Cover strip	●	
Smart Tool Locator® (STL)*		○
E2M® Guards	●	
Drive unit CNC, Motor (max. tool weight 4000 kg)	●	
Drive unit CNC, Hydraulic (tool weight > 4000 kg)		○
Weight		154 kg/m
Pillars for supporting extra wide bottom tools		○
Max. load shoulders		500 t/m

	Standard	Optional
Hydraulic Clamping	●	
Manual Clamping		○
Designed for press brakes with UPB-VII hole pattern	●	
B2 mounting to the lower beam instead of UPB		○
Cover strip with scale	●	
Tx-alignment	●	
Smart Tool Locator® (STL)*		○
E2M® Guards	●	
Drive unit CNC, Motor (max. tool weight 4000 kg)	●	
Drive unit CNC, Hydraulic (tool weight > 4000 kg)		○
Weight		258 kg/m
Pillars for supporting extra wide bottom tools		○
Max. load shoulders		500 t/m

* Not available for Tool Holders with Manual Clamping.

ADAPTION

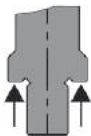

NS V shoulder load

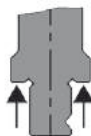

NS VI shoulder load with V-Lock®

MANUAL CLAMPING OF BOTTOM TOOLS



If bottom tool changeovers are not needed often, Premium and Pro Crowning/Bottom Tool Holder models with manual clamping are available as well. Manual Clamping is achieved via clamping bolts at a distance of every 25 mm, in the center 1000 mm and every 100 mm towards each end, allowing the clamping of tool segments as small as 15 mm in length.

OB-I-HC-TY/UPB



OB-I-HC/UPB

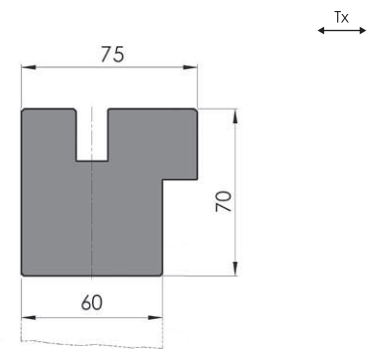
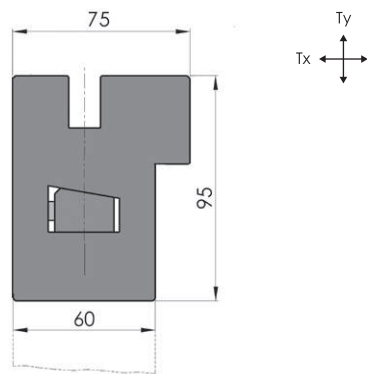

	Standard	Optional
Hydraulic Clamping	●	
Manual Clamping		○
Designed for press brakes with UPB-II hole pattern	●	
ES IV, B2 or B3 mounting**		○
Tx-alignment	●	
Ty-alignment permanently accessible	●	
Weight		45 kg/m
Max. load shoulders		200 t/m

	Standard	Optional
Hydraulic Clamping	●	
Manual Clamping		○
Designed for press brakes with UPB-II hole pattern	●	
ES IV, B2 or B3 mounting**		○
Tx-alignment	●	
Weight		35 kg/m
Max. load shoulders		200 t/m

** Height may change.

ADAPTION

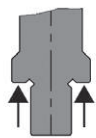

NS V shoulder load

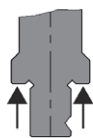

NS VI shoulder load with V-Lock®

TY-ADJUSTMENT



Ty-adjustment is crucial in determining the parallelism between top and bottom tools. Adjustment in Y direction makes it possible to fully compensate for unavoidable - cumulative - processing tolerances in the press brake. Either the top or bottom Tool Holder must be able to do this if one wants to achieve accurate and consistent bending results.

OB-HD-I-HC-TY/UPB

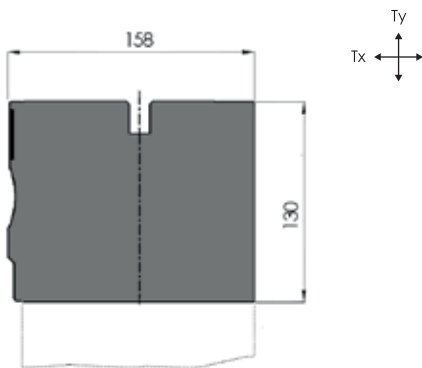

OB-HD-I-HC/UPB

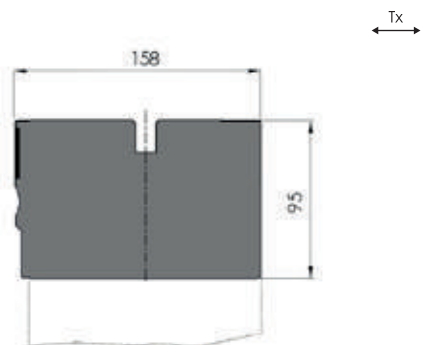

	Standard	Optional
Hydraulic Clamping	●	
Manual Clamping		○
Designed for press brakes with UPB-VI hole pattern	●	
B2 mounting to the lower beam instead of UPB		○
Cover strip with scale	●	
Tx-alignment	●	
Ty-alignment permanently accessible		○
Ty-alignment behind Cover strip	●	
Smart Tool Locator® (STL)*		○
E2M® Guards	●	
Weight	154 kg/m	
Pillars for supporting extra wide bottom tools		○
Max. load shoulders	500 t/m	

	Standard	Optional
Hydraulic Clamping	●	
Manual Clamping		○
Designed for press brakes with UPB-VI hole pattern	●	
B2 mounting to the lower beam instead of UPB		○
Cover strip with scale	●	
Tx-alignment	●	
Smart Tool Locator® (STL)*		○
E2M® Guards	●	
Weight	112 kg/m	
Pillars for supporting extra wide bottom tools		○
Max. load shoulders	500 t/m	

* Not available for Tool Holders with Manual Clamping.

ADAPTION

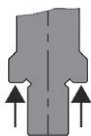

NS V shoulder load



NS VI shoulder load with V-Lock®

EASY-TO-MOVE® (E2M)



This bearing system is designed for quick and safe handling of heavy top and bottom tools in and out of the Tool Holder. The Tool Holders should be equipped with a roll-out prevention (E2M® Guard).

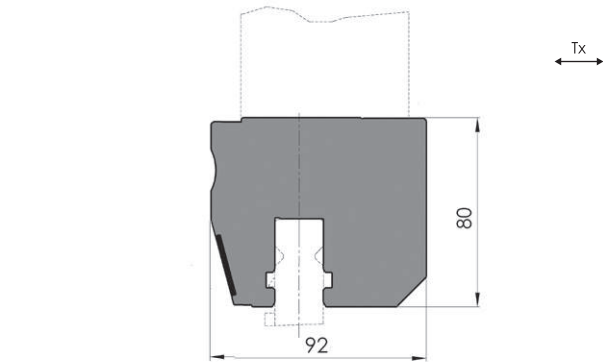

	Standard	Optional
Pneumatic Clamping	●	
Designed for press brakes with UPB-II hole pattern	●	
Cover strip with scale	●	
Tx-alignment	●	
Smart Tool Locator® (STL)		○
Guards	●	
Weight	38 kg/m	
Max. load head/shoulders	180 / 250 t/m	

ADAPTION



NS I head load

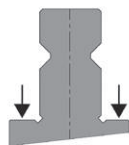

NS II shoulder load

SELF-LOCKING



Tools are clamped using a pneumatically-controlled pair of self-adjusting wedges. When the wedges are engaged (clamped), they become an integral part of the tool. The Self-Locking® principle is suitable for clamping WILA's New Standard top and bottom tools (BIU and OZU). The Premium clamping is also released pneumatically.

NSCL-I-SL-TY/ES I

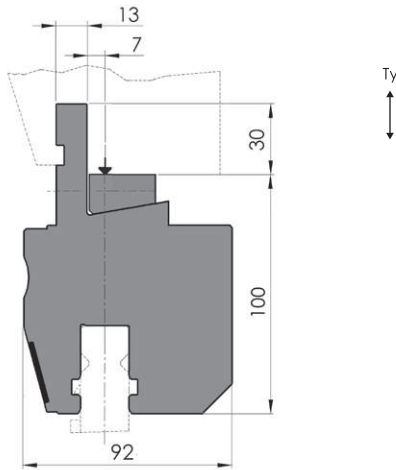

	Standard	Optional
Pneumatic Clamping	●	
Designed for press brakes with European Style I upper beam	●	
Cover strip with scale	●	
Ty-alignment	●	
Smart Tool locator® (STL)		○
Guards	●	
Weight		51 kg/m
Max. load shoulders		180 / 250 t/m

NSCL-I-SL/ES I

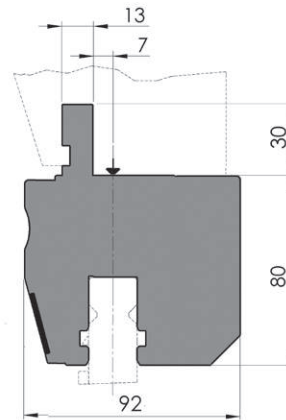

	Standard	Optional
Pneumatic Clamping	●	
Designed for press brakes with European Style I upper beam	●	
Available to suit any existing ram-style		○
Cover strip with scale	●	
Smart Tool locator® (STL)		○
Guards	●	
Weight		42 kg/m
Max. load shoulders		180 / 250 t/m

ADAPTION

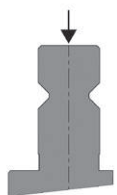

NS I head load

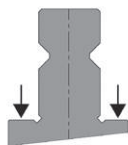

NS II shoulder load

SAFETY-CLICK®



The Safety-Click® is WILA's patented safety mechanism which has been integrated into top tools with a weight up to 12,5 kg. This revolutionary mechanism allows tools to be changed vertically by simply clicking them in and out of the Clamping.

NSCL-I-SL-TY/ES II

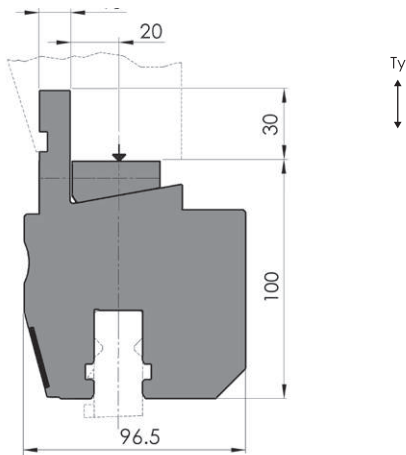

	Standard	Optional
Pneumatic Clamping	●	
Designed for press brakes with European Style II upper beam	●	
Cover strip with scale	●	
Ty-alignment	●	
Smart Tool locator® (STL)		○
Guards	●	
Weight	53 kg/m	
Max. load shoulders	180 / 250 t/m	

NSCL-I-SL/ES II

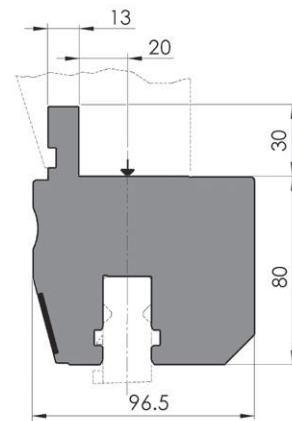

	Standard	Optional
Pneumatic Clamping	●	
Designed for press brakes with European Style II upper beam	●	
Available to suit any existing ram-style		○
Cover strip with scale	●	
Smart Tool locator® (STL)		○
Guards	●	
Weight	45 kg/m	
Max. load shoulders	180 / 250 t/m	

ADAPTION

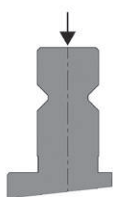

NS I head load

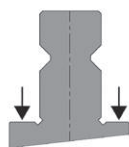

NS II shoulder load

WEBSHOP



The WILA Webshop features a comprehensive overview of WILA's top and bottom tools. The Webshop can be used to request quotes, check prices, find delivery times, and place orders directly or through your preferred ASP. Create your account via: www.wilatooling.com

NSCL-I-SL/AS I

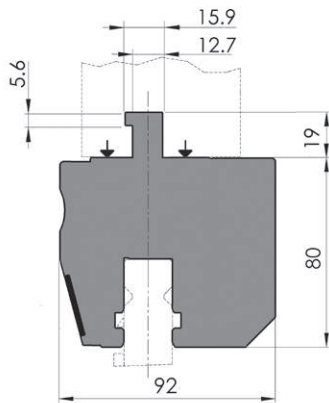

	Standard	Optional
Pneumatic Clamping	●	
Designed for press brakes with American Style I upper beam	●	
Available to suit any existing ram-style		○
Cover strip with scale	●	
Smart Tool locator® (STL)		○
Guards	●	
Weight	41 kg/m	
Max. load shoulders	180 / 250 t/m	

ADAPTION

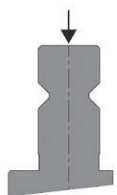

NS I head load

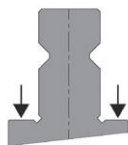

NS II shoulder load

SMART TOOLING



All WILA New Standard Premium tools have a unique DM-code. With the WILA Smart Tooling app you can scan all the tools. After scanning the DM-code you have immediate access to the tool's specifications and the correct tool data files for your press brake control.



NSCR-I-SL/UPB

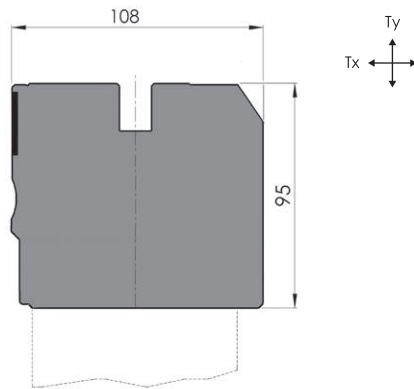

	Standard	Optional
Pneumatic Clamping	●	
Designed for press brakes with UPB-II hole pattern	●	
B2 or B3 mounting		○
Cover strip with scale	●	
Tx-alignment	●	
Ty-alignment permanently accessible		○
Ty-alignment behind Cover strip	●	
Smart Tool locator® (STL)		○
Guard	●	
Drive unit CNC, Motor at one end	●	
Drive unit H, Hand crank assembly at one end		○
Drive unit Hf, manually in the front		○
Weight		70 kg/m
Max. load shoulders		200 t/m

ADAPTION

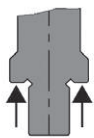

NS V shoulder load

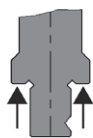

**NS VI shoulder load
with V-Lock®**

E2M® SAFETY ROLLER BEARING: BOTTOM



E2M® bottom tools are provided with an internal lift system. This system is applicable for a tool weight with a maximum of 140 kg and minimum tool length of 200 mm. Minimum width of the tool should be 30 mm.

OB-I-SL-TY/UPB

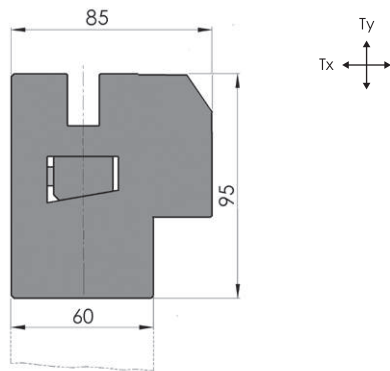

OB-I-SL/UPB

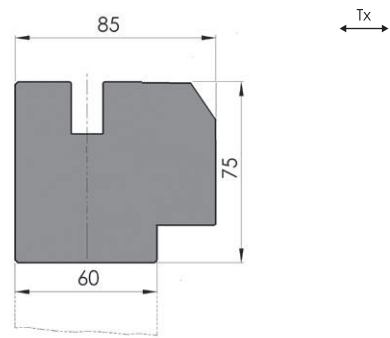

	Standard	Optional
Pneumatic Clamping	●	
Designed for press brakes with UPB-II hole pattern	●	
ES IV, B2 or B3 mounting**		○
Cover strip with scale and Guard		○
Tx-alignment	●	
Ty-alignment permanently accessible	●	
Smart Tool locator® (STL)		○
Weight		53 kg/m
Max. load shoulders		200 t/m

	Standard	Optional
Pneumatic Clamping	●	
Designed for press brakes with UPB-II hole pattern	●	
ES IV,B2 or B3 mounting**		○
Cover strip with scale and Guard		○
Tx-alignment	●	
Smart Tool locator® (STL)		○
Weight		41 kg/m
Max. load shoulders		200 t/m

** Height may change

** Height may change

ADAPTION

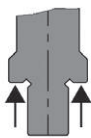

NS V shoulder load



NS VI shoulder load with V-Lock®

PRESS BRAKE PRODUCTIVITY WAX



Press Brake Productivity Wax is a spray that has been specially developed for cleaning, maintaining and protecting WILA tools.

ASCL-I-HC/UPB

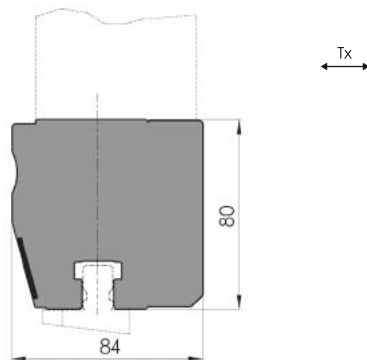

	Standard	Optional
Hydraulic Clamping	●	
Manual Clamping		○
Designed for press brakes with UPB-II hole pattern	●	
Cover strip with scale	●	
Tx-alignment	●	
Smart Tool Locator® (STL)*		○
Guards	●	
Weight	34,5 kg/m	
Max. load shoulders	230 t/m	

* Not available for Tool Holders with Manual Clamping.

ADAPTION

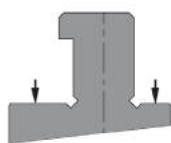

AS I shoulder load

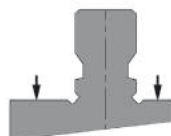

AS II shoulder load

MANUAL CLAMPING SYSTEM



Within the framework of its UPB concept WILA has also included a mechanical clamping system in its program for American Style tools. This is a mechanical system in which the clamping is achieved by a continuous body with clamping plates. The top tools are clamped by manually tightening the clamping plates; the tools are not seated automatically. This mechanical system can be used for both the standard American Style top tools and the American Style top tools WILA re-designed with Safety-Click®.

ASCL-I-HC/ES II

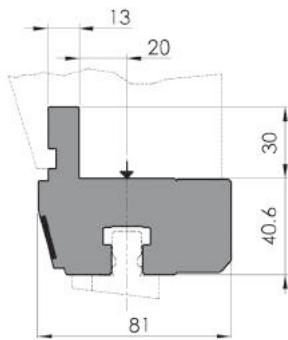

ASCL-I-HC/AS I

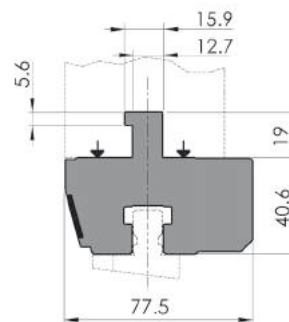

	Standard	Optional
Hydraulic Clamping	●	
Designed for press brakes with European Style II upper beam	●	
Designed for press brakes with European Style I upper beam		○
Cover strip with scale	●	
Guards	●	
Weight		18,5 kg/m
Max. load shoulders		230 t/m

	Standard	Optional
Hydraulic Clamping	●	
Designed for press brakes with American Style I upper beam	●	
Cover strip with scale	●	
Guards	●	
Weight		18,5 kg/m
Max. load shoulders		230 t/m

Smart Tool Locator® (STU) not available for Clamping with working height under 55 mm.

ADAPTION

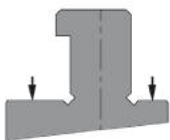

AS I shoulder load

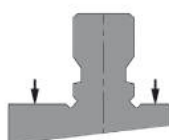

AS II shoulder load

HYDRAULIC POWER PACKS



For use in combination with Tool Holders with Hydraulic Clamping. Operation via push button on the power pack, via remote control, or fully integrated in the press brake. See also page 103.

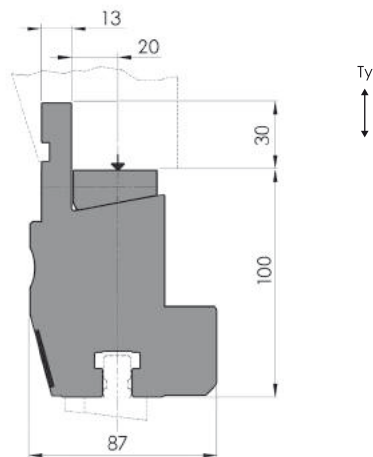

	Standard	Optional
Hydraulic Clamping	●	
Designed for press brakes with European Style II upper beam	●	
Designed for press brakes with European Style I upper beam		○
Cover strip with scale	●	
Ty-alignment	●	
Smart Tool Locator® (STL)		○
Guards	●	
Weight		43 kg/m
Max. load shoulders		230 t/m

ADAPTION

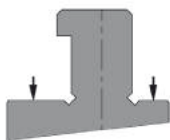

AS I shoulder load

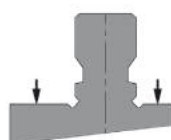

AS II shoulder load

TOOL ADVISOR



This high-end engineering tool allows you to make a decision online about which press brake tools are best suited to your specific bending needs. If the required tool is unavailable as a standard solution, it is possible to immediately design a special tool and order it via the WILA Webshop.



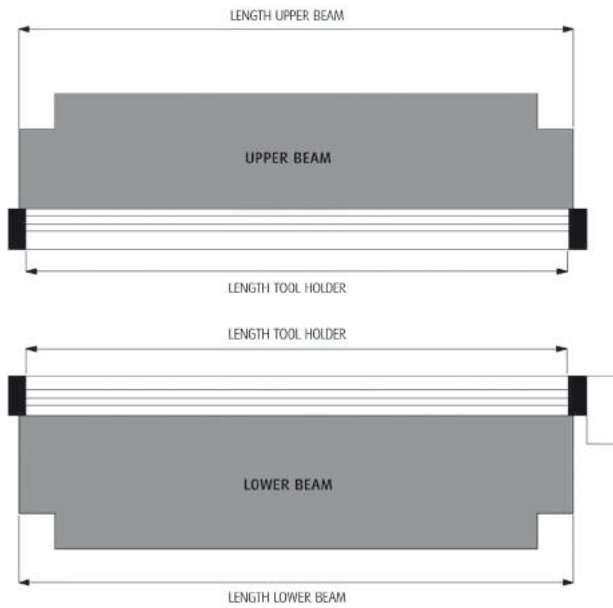

UPPER BEAM

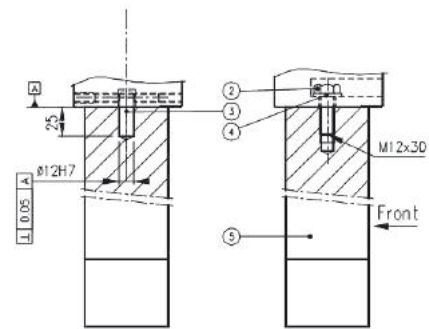
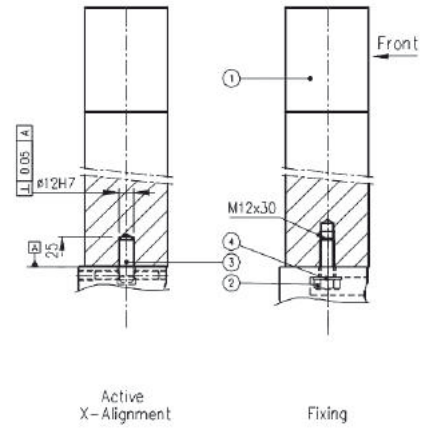

LOWER BEAM

AVAILABLE LENGTHS TOOL HOLDERS	
1020 mm*	5270 mm
1190 mm	5440 mm
1275 mm	5610 mm*
1530 mm*	6120 mm*
1785 mm	6290 mm
2040 mm*	6630 mm*
2210 mm	7140 mm*
2380 mm	7310 mm
2550 mm*	7650 mm*
2720 mm	8160 mm*
3060 mm*	8500 mm
3230 mm	8670 mm*
3570 mm*	9180 mm*
3655 mm	9520 mm
4080 mm*	9690 mm*
4250 mm	10200 mm*
4335 mm *	10710 mm*
4420 mm	11220 mm*
4590 mm*	11730 mm*
4845 mm*	12240 mm*
5100 mm*	

* These Tool Holders are also available with UPB VI and VII pattern (Heavy Duty). For more information about other lengths contact WILA.



MAXIMUM PULL UP WEIGHT TOP TOOLS (SELF-SEATING)			
	Hydraulic Clamping	Mechanical Clamping	Pneumatic Clamping
Premium			
New Standard Premium Clamping	300 kg/m	180 kg/m	100 kg/m
New Standard HD Premium Clamping	1000 kg/m	-	-
Pro			
New Standard Pro Clamping	100 kg/m	180 kg/m	70 kg/m
American Style			
American Style Clamping	75 k/m	-	-

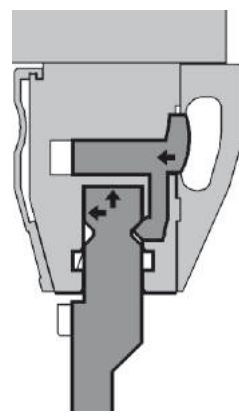

Note: These are maximum pull up weight ratings based on gooseneck style top tools; straight type top tools will have higher weight ratings.

CROWNING CUSTOM STYLE CROWNING

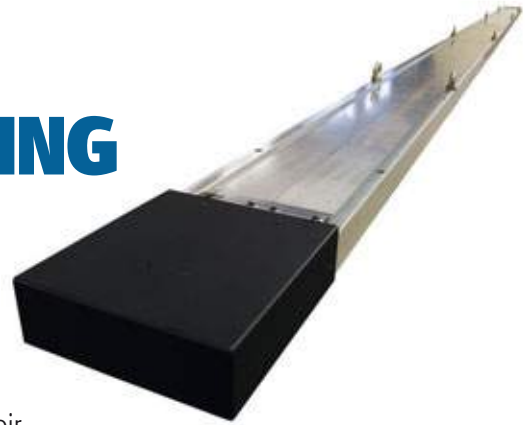

Aside from the standard New Standard Premium and New Standard Pro crowning models, WILA also offers customized crowning systems. These customized crowning systems can be engineered in collaboration with the customer, in order to meet their particular requirements and the tooling style and size range that will be used.

Customized crowning systems have been supplied as long as 15 m, as wide as 600 mm, and to support a tool weight as heavy as 16,000 kg. Some of the most popular customized crowning models are

'CSCR-E-WIDE' (with a wider width for using large V-opening dies or 4-Way dies) and 'CSCR-Q' (suitable for both square Multi-V bottom tools and Single-V-Tools).

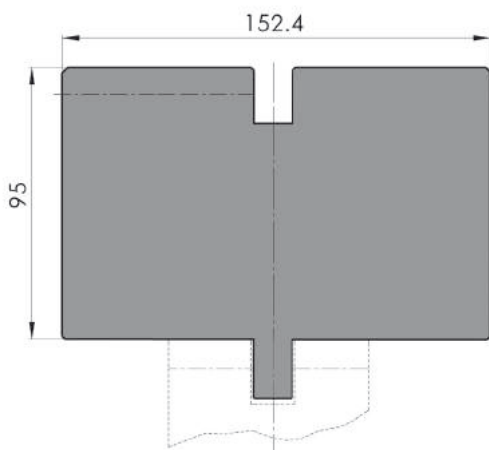
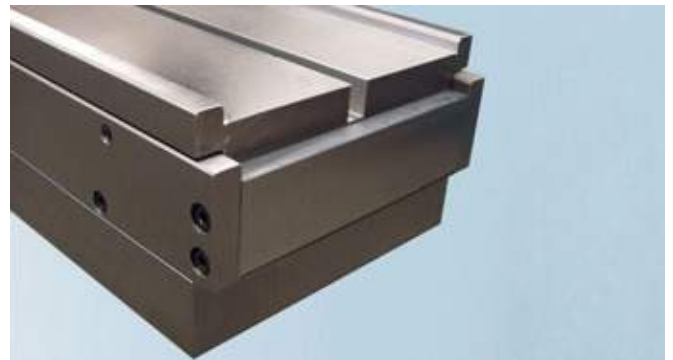

CSCR-E-WIDE

Centrally adjustable Crowning system with Mechanical Clamping and localized Y (Ty) alignment. Suitable for holding single V-tools (New Standard and American Style). Available with A3 Hydraulic Clamping pins as an option. Can be supplied with CNC motor or with H hand crank assembly.

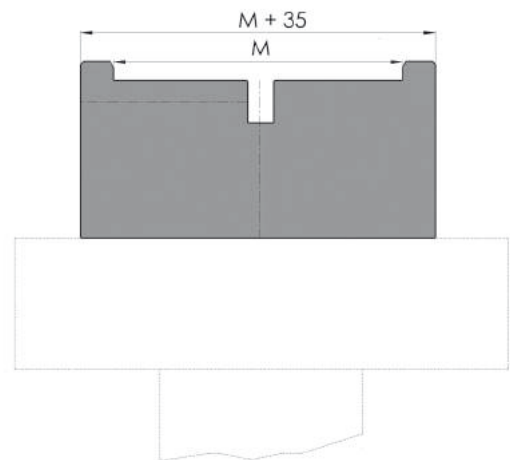

CSCR-Q

Centrally adjustable Crowning system, suitable for holding square bottom tools (M dimensions needed with order) and single V-tools (New Standard and American Style). To be placed on top of the table; with B2 tang mounting optional.

OB-958

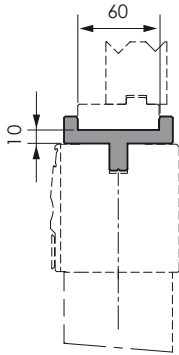

	Standard	Optional
Allows for the use of standard European 60mm V dies on WILA tool holders	●	
Weight		10,1 kg/m
Max. load		200 t/m

OB-953 MANUAL CLAMPING

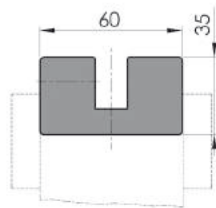

	Standard	Optional
B2, UPB or B3 mounting**		○
Weight		14,7 kg/m
Can be used for New Standard and American Style single V-tools (available also in 515 mm length)	●	
Max. load shoulders		200 t/m

** Height may increase.

ADAPTION

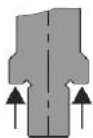

NS V shoulder load

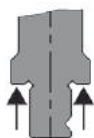

NS VI shoulder load with V-Lock®

BOTTOM TOOL HOLDER OB-958



With optional Bottom Tool Holders model OB-958 every Clamping designed for New Standard and American Style bottom tools can be made suitable for European Style bottom tools with a width of 60mm.

NEW STANDARD TOOLING

For all types of bending technology

WILA tools are available for practically all conceivable bending applications. The multi-faceted range of New Standard tools means you are guaranteed to find a suitable solution. Regardless of thickness or specifications, all sheet types can be bent with extreme precision. And an extra long life-span is also guaranteed. WILA's standard Tooling program has been divided into the New Standard Premium and New Standard Pro product ranges.

FACT SHEET TOOLING AND EXTENDERS												
Remarks	New Standard Premium top and bottom tools					New Standard Pro	Adjustable bottom tools		Flattening tools DDU	Inserts INZU RU	Tool Extenders	
	New Standard Premium	New Standard HD Premium		New Standard BM Premium	New Standard OM Premium		Multi-V-Matic	Multi-V			TSU/HU/TS	HU/THU/DD/OB 958
		Top	Bottom	Tools with special geometry							Top	Bottom
Accuracy												
Working surface precision	+++	+++	+++	+++	+++	++	++	++	++	++	++	++
Durability												
High tensile CrMo steel alloy ≥ 1000 N/mm ²	●	●	●	●	●	-	●	●	-	-	-	○ (DD)
High quality tool steel 600-720 N/mm ²	-	-	OZU-HD	-	-	●	-	-	●	●	●	●
Bending radii are CNC-Deephardened® to minimum 56° HRC, depth ≥ 4 mm	●	●	●	●	●	-	●	●	-	●	-	-
Bending radii are CNC-Deephardened® to minimum 52° HRC, depth ≥ 2 mm	-	-	-	-	-	●	-	-	●	-	-	-
OZU-ZN (for galvanized sheet)	○	-	-	○	○	○	-	-	-	-	-	-
Flexibility												
Easy reversibility because of symmetrical adaption	●	●	●	●	●	●	-	-	-	-	●	-
ATC possible (Gripper, TIPS®)	●	-	-	-	-	-	-	-	-	-	-	-
Vertical* + horizontal loading *Safety-Clicks® required with top tools	●	●	-	●	-	●	-	-	-	-	●	●
Top (BIU/HU/TSU) suitable for all New Standard Premium and Pro Top Tool Holders	●	●	-	●	-	●	-	-	-	-	●	-
Bottom (OZU/HU/THU/DD) suitable for all New Standard Bottom Tool Holders	●	-	●	-	-	●	-	-	-	-	-	●
Bottom tools $V \leq 60$ mm equipped with V-Lock®	●	●	-	●	-	●	-	-	-	-	●	●
Number of available standard top tools	37	3	-	-	-	3	-	-	-	44	-	-
Bottom (OZU/ DDU/HU/THU) have 13 mm adaption designed for use on all press brakes with a Clamping Slot 13,5x 22(WxH)	●	-	●	-	-	●	○	○	●	-	-	-
Available with E2M®	○	○	○	○	○	○	-	-	-	-	○	○
Available with NS III or NS IV adaption	-	-	-	-	○	-	-	-	-	-	-	-
Bottom tools $V \leq 60$ mm equipped with NS VI adaption	●	-	●	-	●	●	-	-	●	-	-	●
Number of available standard bottom tools	62	-	5	-	-	8	1	4	4	19	-	-
Available standard lengths	/1 L=515 mm	●	●	●	●	●	-	-	●	●	●	●
	/2 L=550 mm sectioned	●	●	-	●	●	-	-	-	-	-	-
	/3 L=200 mm sectioned	●	●	-	●	●	-	-	-	-	-	-
	/4 L=150 mm	-	-	-	-	-	-	-	-	-	●	-
	/6 L=200 mm	●	●	-	●	●	-	-	-	-	-	-
	/10 L=475 mm sectioned	-	-	-	●	●	●	-	-	-	-	-
	/11 L= 200 mm sections	●	-	-	●	●	●	-	-	-	-	-
	/12 L=255 mm	●	-	●	●	●	-	-	-	-	-	-
Max. length, mm	515	515	515	515	515	515	6200 mm	-	515	515	515/TS machine length	515/DD +OB 958 machine length
Speed												
Automatically adjustable V-opening	-	-	-	-	-	-	6-51 mm	24-400 mm	-	-	-	-
Automatic seating and aligning of the tooling	●	●	●	●	●	●	-	-	●	-	●	●
Fast tool changing	●	●	●	●	●	●	●	●	●	●	●	●
Adjustment	CNC	-	-	-	-	-	●	○	-	-	-	-
	H	-	-	-	-	-	○	●	-	-	-	-
Use of Safety-Clicks® ≤ 12.5 kg	●	●	-	●	○	●	-	-	-	-	(TSU/4)	-
Use of E2M®	○	○	○	○	○	○	-	-	-	-	○	○
Safety												
Equipped with Safety-Clicks® up to 12,5 kg	●	●	-	●	○	●	-	-	-	-	(TSU-028/030)	-
Equipped with Safety-Pins > 12,5 kg	●	●	-	●	-	●	-	-	-	-	●	● (HU/THU)
Equipped with E2M® >12,5 kg	○	○	○	○	○	○	-	-	-	-	○	○

● - Standard ○ - Optional - - Not available

TOOLING

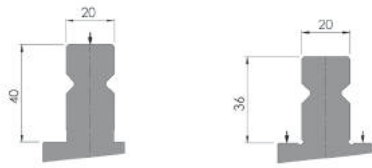

NS I
New Standard I
adaption

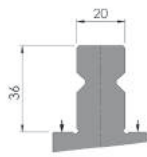

NS II
New Standard II
adaption



Tool slot to suit for NS V
and NS VI adaption

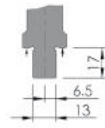

NS V
New Standard V
adaption

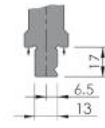

NS VI
New Standard VI
adaption with V-Lock®



E2M®
For bottom tools
> 12,5 kg

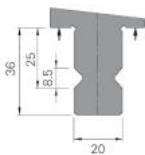

NS IV
New Standard I
adaption

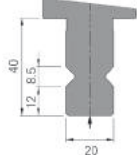

NS III
New Standard II
adaption



Safety-Click®
Applicable for tool
weight up to 12,5 kg
(NS I + II)



Safety-Pin
Applicable for tool weight
> 12,5 kg - < 25kg
(NS I + II)



HD Safety-Pin
Applicable for tool weight
> 12,5 kg - < 150 kg
(NS I + II)

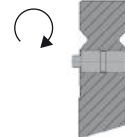

E2M®-HD
Applicable for
tool weight
> 12,5 kg - < 100 kg
(NS I & II)

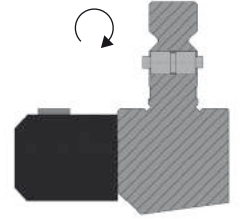

Additional roller bearing for
large Gooseneck tools
equipped with E2M®.
(NS I + II)

Indication	Premium		Pro		AVAILABLE LENGTHS NEW STANDARD TOOLING
	Top	Bottom	Top	Bottom	
/1	●	●	●	●	L=515 mm
/2	●	●			L=550 mm (horn left & right L=100 mm - 20-25-30-35-40-200 mm (OZU bottom tools no horns)
/3	●	●		●	L=200 mm (100-100 mm) no horns
/6	●	●			L=200 mm
/10			●	●	L=475 mm (20-25-30-35-40-125-100-100) no horns
/11	●		●		L=200 mm (horn left & right L=100 - 100 mm)
/12	●	●			L=255 mm

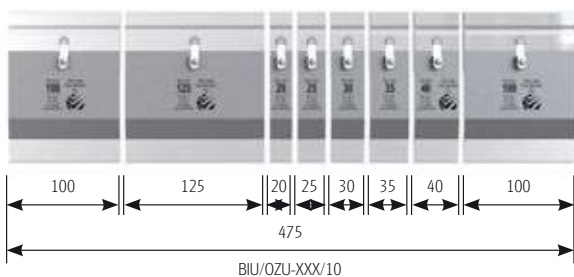
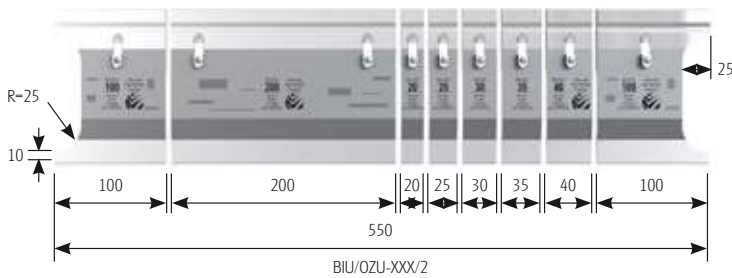
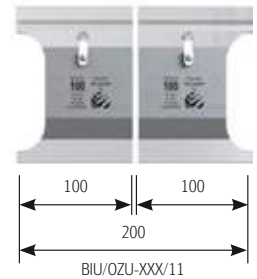
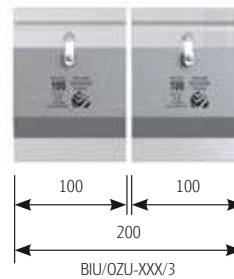

- A** New Standard Premium & New Standard Pro top tools are manufactured as either 'head' or 'shoulder' load tools.
- B** New Standard Premium & New Standard Pro top tools weighing up to 12,5 kg come with our patented Safety-Click® button, for fast and safe vertical loading and unloading.
- C** New Standard Premium and New Standard Pro top tools weighing over 12,5 kg can be equipped as an option with our patented E2M® - Easy to Move - roller bearing system, for extremely easy horizontal loading and unloading.
- D** New Standard Premium & New Standard Pro top tools weighing over 12,5 kg come with fixed Safety-Pins, for safe horizontal loading and unloading.
- E** New Standard Premium & New Standard Pro top tools can be easily reversed for additional bending freedom, such as for clearing a reverse flange.

Tx/Ty

Perfect alignment of tools in horizontal (Tx) and vertical (Ty) direction is key to optimum bend results

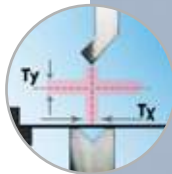

- F** New Standard Premium & New Standard Pro bottom tools can be loaded and unloaded horizontally (sliding in & out) or vertically.
- G** New Standard Premium & New Standard Pro bottom tools can be equipped with our patented E2M® - Easy to Move - roller bearing system, for extremely easy horizontal loading and unloading.
- H** New Standard Premium & New Standard Pro bottom tools, with $V \leq 60$ mm, come with our patented V-Lock® self seating system, for maximum accuracy and safety during bending.
- I** New Standard Premium & New Standard Pro bottom tools come as 'shoulder' load tools.

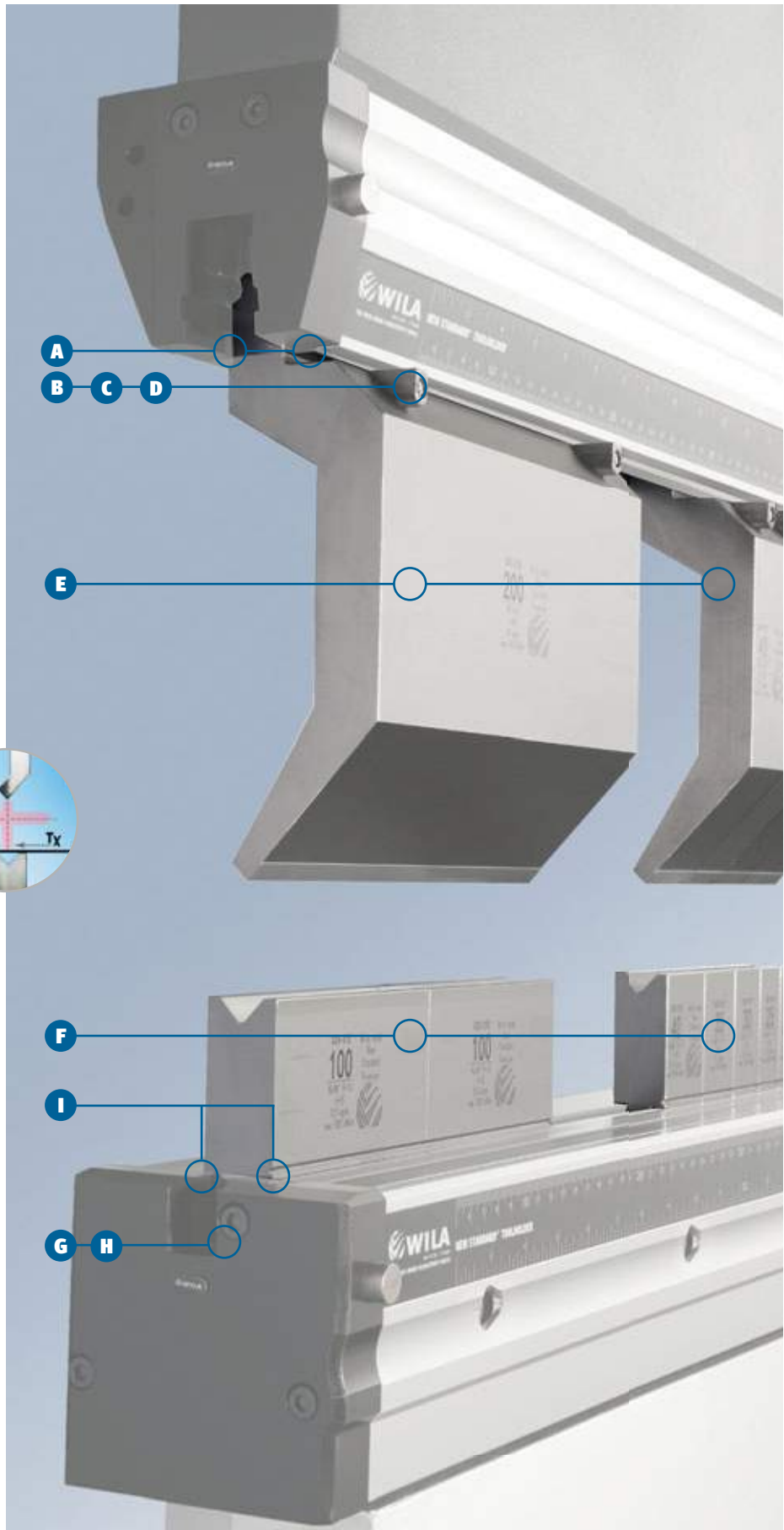

TOOLING

BIU-001

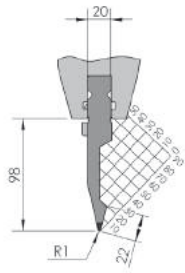

$\alpha=28^\circ$



BIU-004

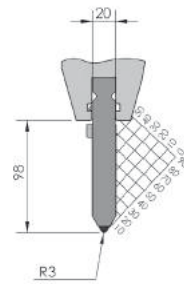

$\alpha=60^\circ$



Type	Length	Weight kg	Max load
BIU-001/1	515 mm	7,5	100 t/m
BIU-001/2 ¹	550 mm - sectioned	8,0	
BIU-001/3 ¹	200 mm - sectioned	2,9	
BIU-001/6 ²	200 mm	2,9	
BIU-001/11	200 mm - sectioned, horns	2,3	
BIU-001/12	255 mm	3,6	

Type	Length	Weight kg	Max load
BIU-004/1	515 mm	10,6	160 t/m
BIU-004/2 ¹	550 mm - sectioned	11,3	
BIU-004/3 ¹	200 mm - sectioned	4,1	
BIU-004/6 ²	200 mm	4,1	
BIU-004/11	200 mm - sectioned, horns	3,3	
BIU-004/12	255 mm	5,2	

BIU-002

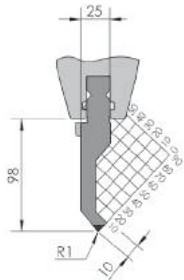

$\alpha=80^\circ$



BIU-003

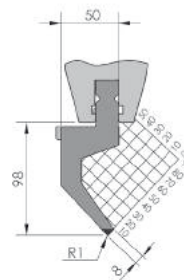

$\alpha=86^\circ$



Type	Length	Weight kg	Max load
BIU-002/1	515 mm	9,1	100 t/m
BIU-002/2 ¹	550 mm - sectioned	9,7	
BIU-002/3 ¹	200 mm - sectioned	3,5	
BIU-002/6 ²	200 mm	3,5	
BIU-002/11	200 mm - sectioned, horns	2,8	
BIU-002/12	255 mm	4,4	

Type	Length	Weight kg	Max load
BIU-003/1	515 mm	12,4	65 t/m
BIU-003/2 ¹	550 mm - sectioned	13,2	
BIU-003/3 ¹	200 mm - sectioned	4,8	
BIU-003/6 ²	200 mm	4,8	
BIU-003/11	200 mm - sectioned, horns	3,7	
BIU-003/12	255 mm	5,8	

¹ Individual tool sections also available. ² /6 will be phased out.

ADAPTION

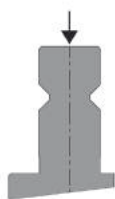

NS I head load

WEBSHOP



The WILA Webshop features a comprehensive overview of WILA's top and bottom tools. The Webshop can be used to request quotes, check prices, find delivery times, and place orders directly or through your preferred ASP. Create your account via: www.wilatooling.com

BIU-011

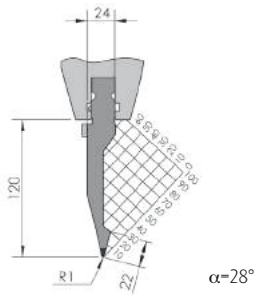

BIU-014

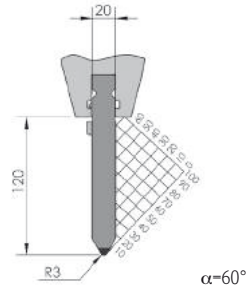

Type	Length	Weight kg	Max load
BIU-011/1	515 mm	9,5	100 t/m
BIU-011/2 ¹	550 mm - sectioned	10,2	
BIU-011/3 ¹	200 mm - sectioned	3,7	
BIU-011/6 ³	200 mm	3,7	
BIU-011/11	200 mm - sectioned, horns	6,4	
BIU-011/12	255 mm	4,6	

Type	Length	Weight kg	Max load
BIU-014/1	515 mm	12,2	160 t/m
BIU-014/2 ¹	550 mm - sectioned	13,0	
BIU-014/3 ¹	200 mm - sectioned	4,7	
BIU-014/6 ³	200 mm	4,7	
BIU-014/11	200 mm - sectioned, horns	3,8	
BIU-014/12	255 mm	6,1	

BIU-012

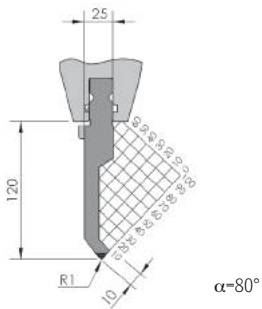

BIU-013

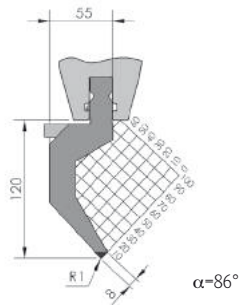

Type	Length	Weight kg	Max load
BIU-012/1	515 mm	9,8	100 t/m
BIU-012/2 ¹	550 mm - sectioned	10,5	
BIU-012/3 ¹	200 mm - sectioned	3,8	
BIU-012/6 ³	200 mm	3,8	
BIU-012/11	200 mm - sectioned, horns	3,1	
BIU-012/12	255 mm	4,9	

Type	Length	Weight kg	Max load
BIU-013/1 ²	515 mm	15,5	65 t/m
BIU-E2M-013/1	515 mm	15,5	
BIU-013/2 ¹	550 mm - sectioned	16,5	
BIU-013/3 ¹	200 mm - sectioned	6,0	
BIU-013/6 ³	200 mm	6,0	
BIU-013/11	200 mm - sectioned, horns	4,6	
BIU-013/12	255 mm	8,8	

¹ Individual tool sections also available. ² Provided with fixed Safety-Pins (see page 42). ³ /6 will be phased out

SEGMENTED TOOLING PROVIDES COMPLETE FLEXIBILITY

Create any desired tooling length from 20 mm to machine length in 5 mm increments by combining tool segments.

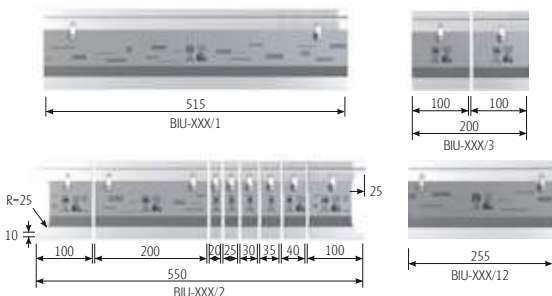

Examples of tool segments combined for various machine lengths			
550 mm segmented set	255 mm	515 mm	Total length
1	1	1	1320 mm
1	1	2	1835 mm
1	2	3	2605 mm
1		5	3125 mm
1		6	3640 mm
1	1	7	4410 mm

BIU-015

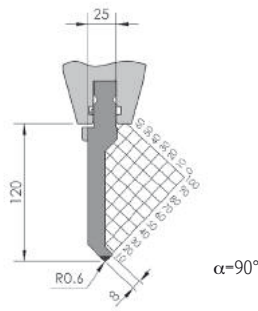

BIU-016

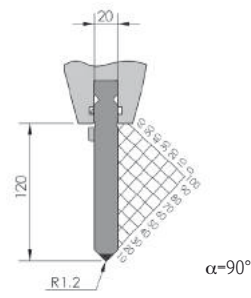

Type	Length	Weight kg	Max load
BIU-015/1	515 mm	11,0	60 t/m
BIU-015/2 ¹	550 mm - sectioned	11,7	
BIU-015/3 ¹	200 mm - sectioned	4,3	
BIU-015/6 ²	200 mm	4,3	
BIU-015/11	200 mm - sectioned, horns	3,4	
BIU-015/12	255 mm	5,3	

Type	Length	Weight kg	Max load
BIU-016/1	515 mm	12,4	100 t/m
BIU-016/2 ¹	550 mm - sectioned	13,3	
BIU-016/3 ¹	200 mm - sectioned	4,8	
BIU-016/6 ²	200 mm	4,8	
BIU-016/11	200 mm - sectioned, horns	4,3	
BIU-016/12	255 mm	6,1	

TOOLING

NEW STANDARD PREMIUM

¹ Individual tool sections also available. ² /6 will be phased out.

ADAPTION



NS I head load

SAFETY-CLICK®



The Safety-Click® is WILA's patented safety mechanism which has been integrated into top tools with a weight up to 12,5 kg. This revolutionary mechanism allows tools to be changed vertically by simply clicking them in and out of the Clamping.

BIU-021

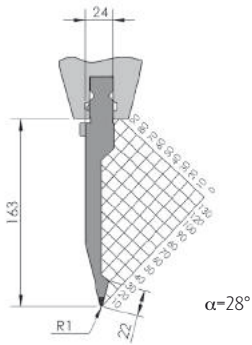

BIU-221

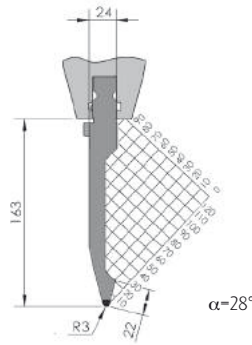

Type	Length	Weight kg	Max load
BIU-021/1	515 mm	12,4	70 t/m
BIU-021/2 ¹	550 mm - sectioned	13,2	
BIU-021/3 ¹	200 mm - sectioned	4,8	
BIU-021/6 ³	200 mm	4,8	
BIU-021/11	200 mm - sectioned, horns	3,7	
BIU-021/12	255 mm	6,0	

Type	Length	Weight kg	Max load
BIU-221/1	515 mm	12,5	100 t/m
BIU-221/2 ¹	550 mm - sectioned	13,4	
BIU-221/3 ¹	200 mm - sectioned	4,9	
BIU-221/6 ³	200 mm	4,9	
BIU-221/11	200 mm - sectioned, horns	3,8	
BIU-221/12	255 mm	6,2	

BIU-029

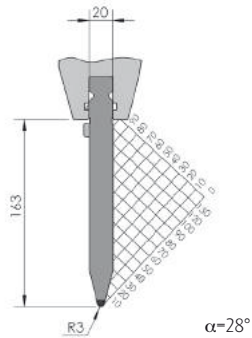

BIU-024

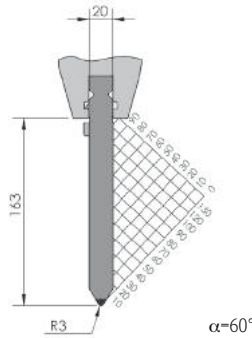

Type	Length	Weight kg	Max load
BIU-029/1 ²	515 mm	15,6	160 t/m
BIU-E2M-029/1	515 mm	15,6	
BIU-029/2 ¹	550 mm - sectioned	16,7	
BIU-029/3 ¹	200 mm - sectioned	6,1	
BIU-029/6 ³	200 mm	6,1	
BIU-029/11	200 mm - sectioned, horns	4,7	
BIU-029/12	255 mm	7,6	

Type	Length	Weight kg	Max load
BIU-024/1 ²	515 mm	16,0	160 t/m
BIU-E2M-024/1	515 mm	16,0	
BIU-024/2 ¹	550 mm - sectioned	17,1	
BIU-024/3 ¹	200 mm - sectioned	6,2	
BIU-024/6 ³	200 mm	6,2	
BIU-024/11	200 mm - sectioned, horns	4,8	
BIU-024/12	255 mm	7,9	

¹ Individual tool sections also available. ² Provided with fixed Safety-Pins (see page 42). ³ /6 will be phased out

SEGMENTED TOOLING PROVIDES COMPLETE FLEXIBILITY

Create any desired tooling length from 20 mm to machine length in 5 mm increments by combining tool segments.

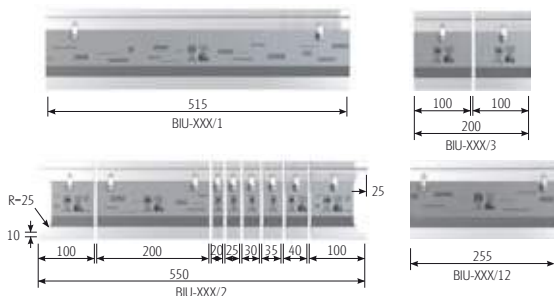

Examples of tool segments combined for various machine lengths			
550 mm segmented set	255 mm	515 mm	Total length
1	1	1	1320 mm
1	1	2	1835 mm
1	2	3	2605 mm
1		5	3125 mm
1		6	3640 mm
1	1	7	4410 mm

BIU-222

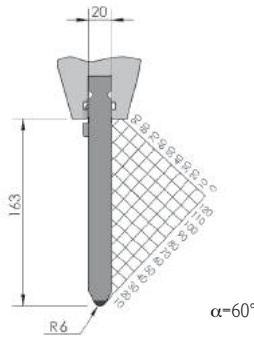

BIU-137

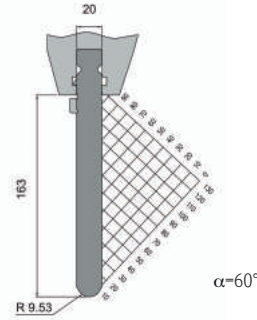

Type	Length	Weight kg	Max load
BIU-222/1 ²	515 mm	15,8	160 t/m
BIU-E2M-222/1	515 mm	15,8	
BIU-222/2 ¹	550 mm - sectioned	16,9	
BIU-222/3 ¹	200 mm - sectioned	6,2	
BIU-222/6 ³	200 mm	6,2	
BIU-222/11	200 mm - sectioned, horns	5,0	
BIU-222/12	255 mm	8,0	

Type	Length	Weight kg	Max load
BIU-137/1 ²	515 mm	16,2	190 t/m
BIU-E2M-137/1	515 mm	16,2	
BIU-137/2 ¹	550 mm - sectioned	17,3	
BIU-137/3 ¹	200 mm - sectioned	6,3	
BIU-137/6 ³	200 mm	6,3	
BIU-137/11	200 mm - sectioned, horns	4,9	
BIU-137/12	255 mm	8,0	

BIU-223

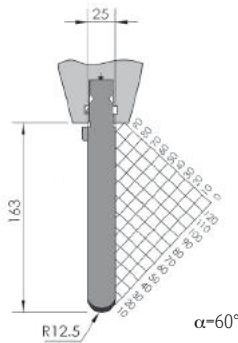

BIU-226

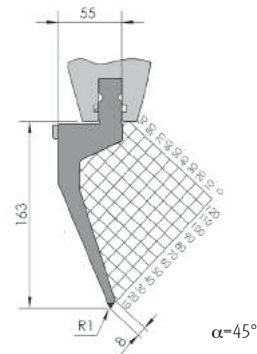

Type	Length	Weight kg	Max load
BIU-223/1 ²	515 mm	18,9	225 t/m
BIU-E2M-223/1	515 mm	18,9	
BIU-223/2 ¹	550 mm - sectioned	20,2	
BIU-223/3 ¹	200 mm - sectioned	7,4	
BIU-223/6 ³	200 mm	7,4	
BIU-223/11	200 mm - sectioned, horns	5,9	
BIU-223/12	255 mm	8,1	

Type	Length	Weight kg	Max load
BIU-226/1 ²	515 mm	15,2	40 t/m
BIU-E2M-226/1	515 mm	15,2	
BIU-226/2 ¹	550 mm - sectioned	16,2	
BIU-226/3 ¹	200 mm - sectioned	5,9	
BIU-226/6 ³	200 mm	5,9	
BIU-226/11	200 mm - sectioned, horns	4,5	
BIU-226/12	255 mm	7,5	

¹ Individual tool sections also available. ² Provided with fixed Safety-Pins (see page 42). ³ /6 will be phased out

ADAPTION

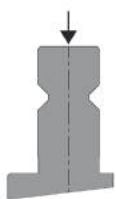

NS I head load

E2M SAFETY ROLLER BEARING



New Standard E2M[®] top and bottom tools are equipped with special (pre-assembled) bearings, which allow you to move the tools laterally in a non-clamped state quickly and safely.

BIU-022

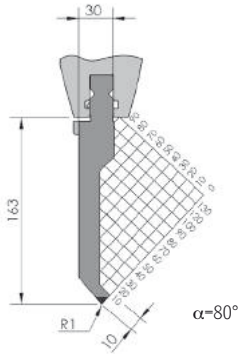

BIU-026

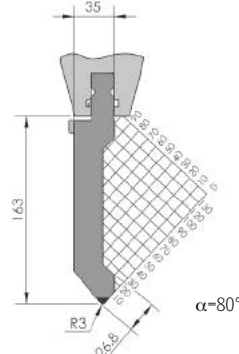

Type	Length	Weight kg	Max load
BIU-022/1 ²	515 mm	16,2	80 t/m
BIU-E2M-022/1	515 mm	16,2	
BIU-022/2 ¹	550 mm - sectioned	17,3	
BIU-022/3 ¹	200 mm - sectioned	6,3	
BIU-022/6 ³	200 mm	6,3	
BIU-022/11	200 mm - sectioned, horns	4,9	
BIU-022/12	255 mm	7,9	

Type	Length	Weight kg	Max load
BIU-026/1 ²	515 mm	19,6	140 t/m
BIU-E2M-026/1	515 mm	19,6	
BIU-026/2 ¹	550 mm - sectioned	20,9	
BIU-026/3 ¹	200 mm - sectioned	7,6	
BIU-026/6 ³	200 mm	7,6	
BIU-026/11	200 mm - sectioned, horns	6,0	
BIU-026/12	255 mm	9,8	

BIU-225

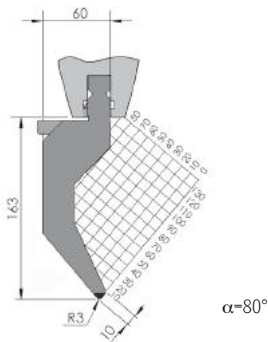

BIU-025

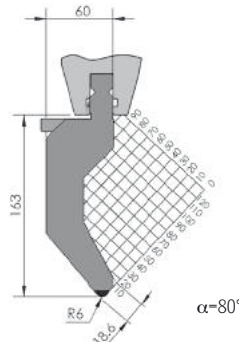

Type	Length	Weight kg	Max load
BIU-225/1 ²	515 mm	24,6	90 t/m
BIU-E2M-225/1	515 mm	24,6	
BIU-225/2 ¹	550 mm - sectioned	26,2	
BIU-225/3 ¹	200 mm - sectioned	9,6	
BIU-225/6 ³	200 mm	9,6	
BIU-225/11	200 mm - sectioned, horns	7,4	
BIU-225/12 ²	255 mm	12,2	

Type	Length	Weight kg	Max load
BIU-025/1 ²	515 mm	27,7	130 t/m
BIU-E2M-025/1	515 mm	27,7	
BIU-025/2 ¹	550 mm - sectioned	29,6	
BIU-025/3 ¹	200 mm - sectioned	10,8	
BIU-025/6 ³	200 mm	10,8	
BIU-025/11	200 mm - sectioned, horns	8,2	
BIU-025/12 ²	255 mm	13,5	

¹ Individual tool sections also available. ² Provided with fixed Safety-Pins (see page 42). ³ /6 will be phased out

SEGMENTED TOOLING PROVIDES COMPLETE FLEXIBILITY

Create any desired tooling length from 20 mm to machine length in 5 mm increments by combining tool segments.

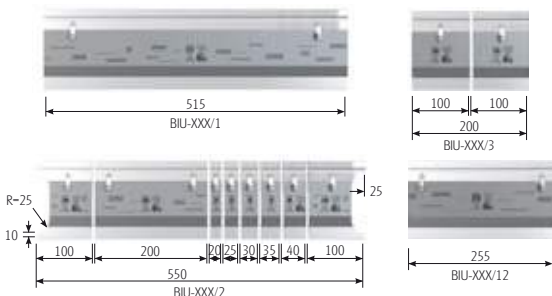

Examples of tool segments combined for various machine lengths			
550 mm segmented set	255 mm	515 mm	Total length
1	1	1	1320 mm
1	1	2	1835 mm
1	2	3	2605 mm
1		5	3125 mm
1		6	3640 mm
1	1	7	4410 mm

BIU-224

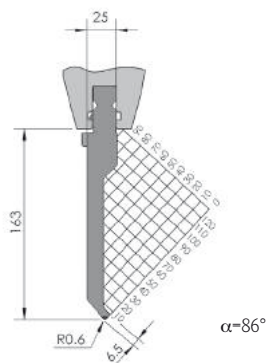

BIU-023

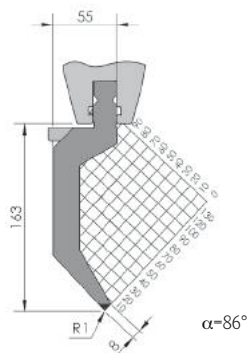

Type	Length	Weight kg	Max load
BIU-224/1 ²	515 mm	12,2	45 t/m
BIU-224/2 ¹	550 mm - sectioned	13,0	
BIU-224/3 ¹	200 mm - sectioned	4,7	
BIU-224/6 ³	200 mm	4,7	
BIU-224/11	200 mm - sectioned, horns	3,9	
BIU-224/12	255 mm	7,9	

Type	Length	Weight kg	Max load
BIU-023/1 ²	515 mm	19,6	65 t/m
BIU-E2M-023/1	515 mm	19,6	
BIU-023/2 ¹	550 mm - sectioned	20,9	
BIU-023/3 ¹	200 mm - sectioned	7,6	
BIU-023/6 ³	200 mm	7,6	
BIU-023/11	200 mm - sectioned, horns	5,8	
BIU-023/12	255 mm	9,5	

TOOLING

NEW STANDARD PREMIUM

¹ Individual tool sections also available. ² Provided with fixed Safety-Pins (see page 42). ³ /6 will be phased out

ADAPTION

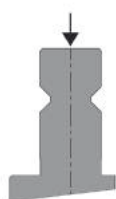

NS I head load

CNC-DEEPHARDENING®



Almost all press brake tools produced by WILA are CNC-Deephardened®. The same applies to WILA's New Standard Premium Tool Holders. This makes them extremely robust and durable. Our New Standard Premium Tool Holders are hardened as shown here.

BIU-031

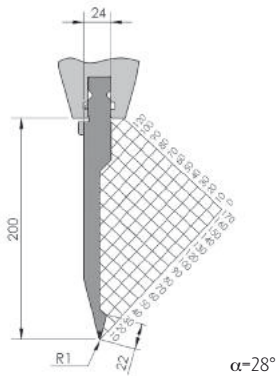

BIU-231

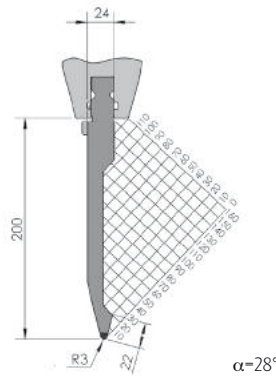

Type	Length	Weight kg	Max load
BIU-031/1 ²	515 mm	15,0	60 t/m
BIU-E2M-031/1	515 mm	15,0	
BIU-031/2 ¹	550 mm - sectioned	16,1	
BIU-031/3 ¹	200 mm - sectioned	5,8	
BIU-031/6 ³	200 mm	5,8	
BIU-031/11	200 mm - sectioned, horns	4,5	
BIU-031/12	255 mm	7,3	

Type	Length	Weight kg	Max load
BIU-231/1 ²	515 mm	15,2	100 t/m
BIU-E2M-231/1	515 mm	15,2	
BIU-231/2 ¹	550 mm - sectioned	16,2	
BIU-231/3 ¹	200 mm - sectioned	5,9	
BIU-231/6 ³	200 mm	5,9	
BIU-231/11	200 mm - sectioned, horns	4,7	
BIU-231/12	255 mm	7,5	

BIU-034

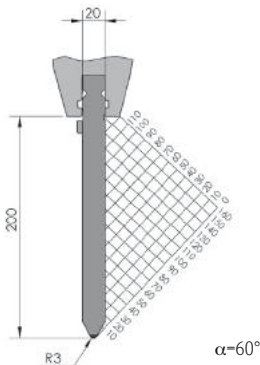

BIU-037

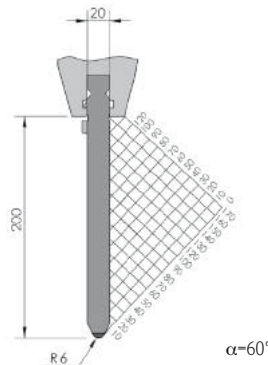

Type	Length	Weight kg	Max load
BIU-034/1 ²	515 mm	18,8	160 t/m
BIU-E2M-034/1	515 mm	18,8	
BIU-034/2 ¹	550 mm - sectioned	20,1	
BIU-034/3 ¹	200 mm - sectioned	7,3	
BIU-034/6 ³	200 mm	7,3	
BIU-034/11	200 mm - sectioned, horns	5,7	
BIU-034/12	255 mm	9,4	

Type	Length	Weight kg	Max load
BIU-037/1 ²	515 mm	18,8	160 t/m
BIU-E2M-037/1	515 mm	18,8	
BIU-037/2 ¹	550 mm - sectioned	20,1	
BIU-037/3 ¹	200 mm - sectioned	7,3	
BIU-037/6 ³	200 mm	7,3	
BIU-037/11	200 mm - sectioned, horns	5,7	
BIU-037/12	255 mm	9,5	

¹ Individual tool sections also available. ² Provided with fixed Safety-Pins (see page 42). ³ /6 will be phased out

SEGMENTED TOOLING PROVIDES COMPLETE FLEXIBILITY

Create any desired tooling length from 20 mm to machine length in 5 mm increments by combining tool segments.

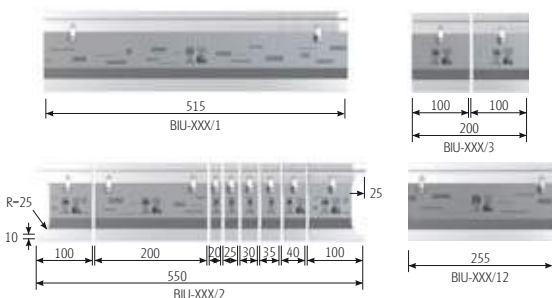

Examples of tool segments combined for various machine lengths			
550 mm segmented set	255 mm	515 mm	Total length
1	1	1	1320 mm
1	1	2	1835 mm
1	2	3	2605 mm
1		5	3125 mm
1		6	3640 mm
1	1	7	4410 mm

BIU-038

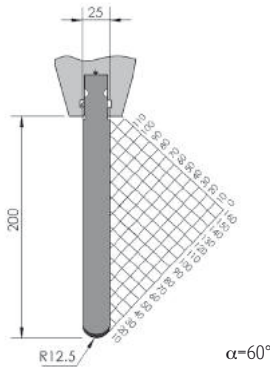

Type	Length	Weight kg	Max load
BIU-038/1 ²	515 mm	22,7	225 t/m
BIU-E2M-038/1	515 mm	22,7	
BIU-038/2 ¹	550 mm - sectioned	24,2	
BIU-038/3 ¹	200 mm - sectioned	8,8	
BIU-038/6 ³	200 mm	8,8	
BIU-038/11	200 mm - sectioned, horns	7,0	
BIU-038/12	255 mm	11,2	

BIU-032

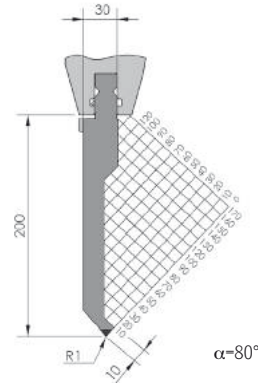

Type	Length	Weight kg	Max load
BIU-032/1 ²	515 mm	19,8	80 t/m
BIU-E2M-032/1	515 mm	19,8	
BIU-032/2 ¹	550 mm - sectioned	21,1	
BIU-032/3 ¹	200 mm - sectioned	7,7	
BIU-032/6 ³	200 mm	7,7	
BIU-032/11	200 mm - sectioned, horns	6,0	
BIU-032/12	255 mm	9,5	

BIU-233

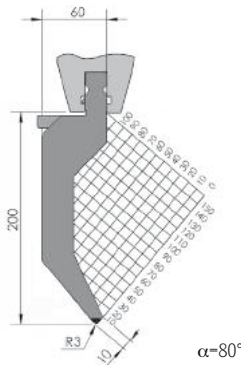

Type	Length	Weight kg	Max load
BIU-233/1 ²	515 mm	28,8	90 t/m
BIU-E2M-233/1	515 mm	28,8	
BIU-233/2 ¹	550 mm - sectioned	30,8	
BIU-233/3 ¹	200 mm - sectioned	11,2	
BIU-233/6 ³	200 mm	11,2	
BIU-233/11	200 mm - sectioned, horns	8,7	
BIU-233/12 ²	255 mm	14,3	

BIU-235

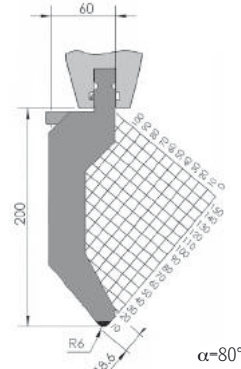

Type	Length	Weight kg	Max load
BIU-235/1 ²	515 mm	32,2	130 t/m
BIU-E2M-235/1	515 mm	32,2	
BIU-235/2 ¹	550 mm - sectioned	34,3	
BIU-235/3 ¹	200 mm - sectioned	12,5	
BIU-235/6 ²	200 mm	12,5	
BIU-235/11	200 mm - sectioned, horns	9,6	
BIU-235/12 ²	255 mm	15,8	

¹ Individual tool sections also available. ² Provided with fixed Safety-Pins (see page 42). ³ /6 will be phased out

ADAPTION



NS I head load

REVERSIBLE TOOLS



Because New Standard and American Style tools are symmetrical in relation to the centerline, these (top) tools can be easily rotated, such as when bending a reverse flange with a gooseneck tool.

BIU-033

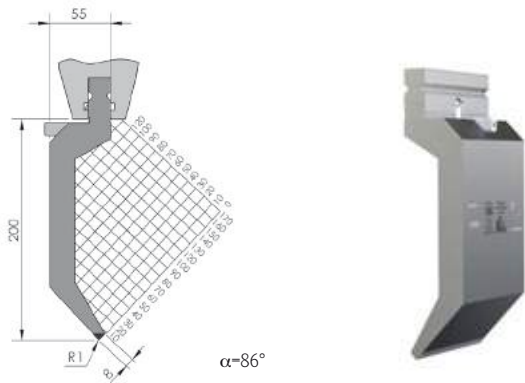

Type	Length	Weight kg	Max load
BIU-033/1 ²	515 mm	23,1	50 t/m
BIU-E2M-033/1	515 mm	23,1	
BIU-033/2 ¹	550 mm - sectioned	24,6	
BIU-033/3 ¹	200 mm - sectioned	9,0	
BIU-033/6 ³	200 mm	9,0	
BIU-033/11	200 mm - sectioned, horns	6,8	
BIU-033/12	255 mm	11,2	

BIU-035

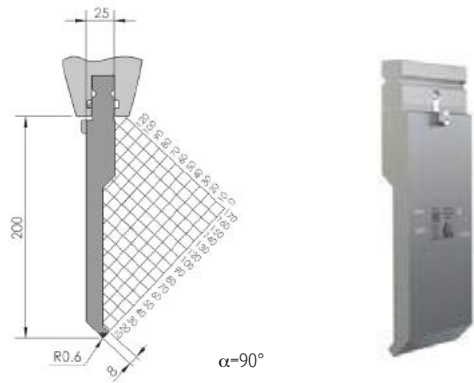

Type	Length	Weight kg	Max load
BIU-035/1 ²	515 mm	17,4	60 t/m
BIU-E2M-035/1	515 mm	17,4	
BIU-035/2 ¹	550 mm - sectioned	18,5	
BIU-035/3 ¹	200 mm - sectioned	6,7	
BIU-035/6 ³	200 mm	6,7	
BIU-035/11	200 mm - sectioned, horns	5,2	
BIU-035/12	255 mm	8,4	

BIU-036

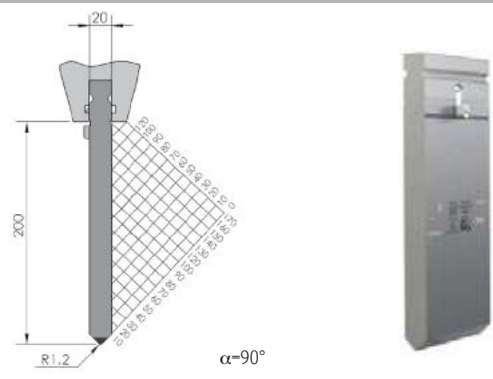

Type	Length	Weight kg	Max load
BIU-036/1 ²	515 mm	19,0	100 t/m
BIU-E2M-036/1	515 mm	19,0	
BIU-036/2 ¹	550 mm - sectioned	20,3	
BIU-036/3 ¹	200 mm - sectioned	7,4	
BIU-036/6 ³	200 mm	7,4	
BIU-036/11	200 mm - sectioned, horns	5,8	
BIU-036/12	255 mm	9,5	

BIU-237

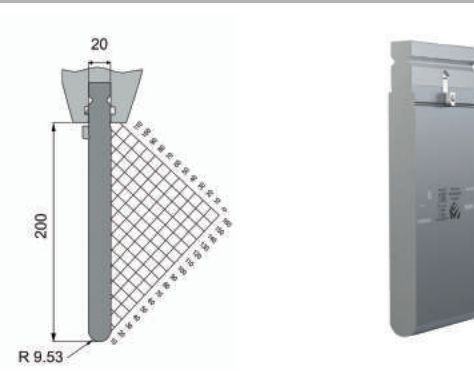

Type	Length	Weight kg	Max load
BIU-237/1 ²	515 mm	19,3	190 t/m
BIU-E2M-237/1	515 mm	19,3	
BIU-237/2 ¹	550 mm - sectioned	20,6	
BIU-237/3 ¹	200 mm - sectioned	7,5	
BIU-237/6 ³	200 mm	7,5	
BIU-237/11	200 mm - sectioned, horns	5,9	
BIU-237/12	255 mm	9,5	

¹ Individual tool sections also available. ² Provided with fixed Safety-Pins (see page 42). ³ /6 will be phased out

SEGMENTED TOOLING PROVIDES COMPLETE FLEXIBILITY

Create any desired tooling length from 20 mm to machine length in 5 mm increments by combining tool segments.

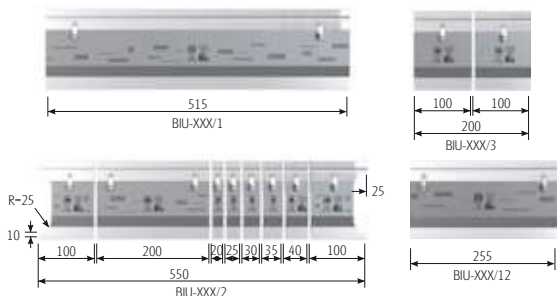

Examples of tool segments combined for various machine lengths			
550 mm segmented set	255 mm	515 mm	Total length
1	1	1	1320 mm
1	1	2	1835 mm
1	2	3	2605 mm
1		5	3125 mm
1		6	3640 mm
1	1	7	4410 mm

OZU-061

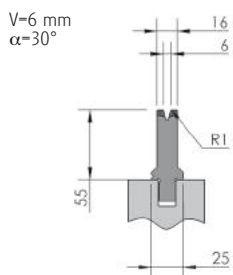

OZU-051

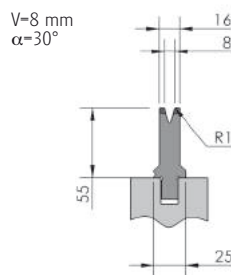

Type	Length	Weight kg	Max load
OZU-061/1	515 mm	4,9	80 t/m $\alpha=90^\circ$
OZU-061/2 ¹	550 mm - sectioned	5,2	
OZU-061/3 ¹	200 mm - sectioned	1,9	
OZU-061/6 ²	200 mm	1,9	
OZU-061/12	255 mm	2,2	

Type	Length	Weight kg	Max load
OZU-051/1	515 mm	4,9	80 t/m $\alpha=90^\circ$
OZU-051/2 ¹	550 mm - sectioned	5,2	
OZU-051/3 ¹	200 mm - sectioned	1,9	
OZU-051/6 ²	200 mm	1,9	
OZU-051/12	255 mm	2,2	

OZU-062

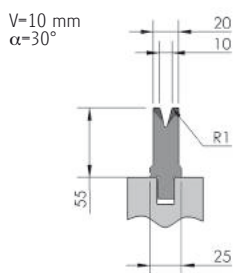

OZU-052

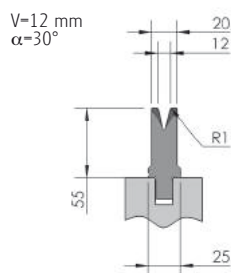

Type	Length	Weight kg	Max load
OZU-062/1	515 mm	5,4	80 t/m $\alpha=90^\circ$
OZU-062/2 ¹	550 mm - sectioned	5,8	
OZU-062/3 ¹	200 mm - sectioned	2,1	
OZU-062/6 ²	200 mm	2,1	
OZU-062/12	255 mm	2,5	

Type	Length	Weight kg	Max load
OZU-052/1	515 mm	5,2	80 t/m $\alpha=90^\circ$
OZU-052/2 ¹	550 mm - sectioned	5,5	
OZU-052/3 ¹	200 mm - sectioned	2,0	
OZU-052/6 ²	200 mm	2,0	
OZU-052/12	255 mm	2,4	

¹ Individual tool sections also available. ² /6 will be phased out.

ADAPTION

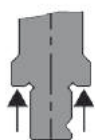

NS VI shoulder load with V-Lock®

V-LOCK®



The V-Lock® improves the clamping and positioning of bottom tools. A groove in the tool tang allows specially designed clamping pins to automatically align and firmly clamp bottom tools in both X and Y directions.

OZU-053

V=16 mm
α=30°

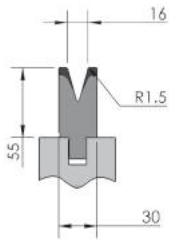

OZU-063

V=20 mm
α=30°

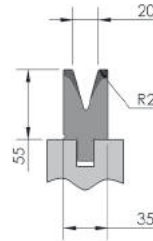

Type	Length	Weight kg	Max load
OZU-053/1	515 mm	7,0	80 t/m α=90°
OZU-053/2 ¹	550 mm - sectioned	7,4	
OZU-053/3 ¹	200 mm - sectioned	2,7	
OZU-053/6 ²	200 mm	2,7	
OZU-053/12	255 mm	3,3	

Type	Length	Weight kg	Max load
OZU-063/1	515 mm	7,7	80 t/m α=90°
OZU-063/2 ¹	550 mm - sectioned	8,3	
OZU-063/3 ¹	200 mm - sectioned	3,0	
OZU-063/6 ²	200 mm	3,0	
OZU-063/12	255 mm	3,5	

OZU-054

V=24 mm
α=30°

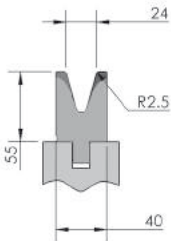

OZU-361

V=6 mm
α=30°

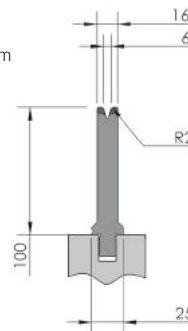

Type	Length	Weight kg	Max load
OZU-054/1	515 mm	8,2	80 t/m α=90°
OZU-054/2 ¹	550 mm - sectioned	8,8	
OZU-054/3 ¹	200 mm - sectioned	3,2	
OZU-054/6 ²	200 mm	3,2	
OZU-054/12	255 mm	3,8	

Type	Length	Weight kg	Max load
OZU-361/1	515 mm	7,8	80 t/m α=90°
OZU-361/2 ¹	550 mm - sectioned	8,4	
OZU-361/3 ¹	200 mm - sectioned	3,0	
OZU-361/6 ²	200 mm	3,0	
OZU-361/12	255 mm	3,7	

¹ Individual tool sections also available. ² /6 will be phased out.

SEGMENTED TOOLING PROVIDES COMPLETE FLEXIBILITY

Create any desired tooling length from 20 mm to machine length in 5 mm increments by combining tool segments.



Examples of tool segments combined for various machine lengths			
550 mm segmented set	255 mm	515 mm	Total length
1	1	1	1320 mm
1	1	2	1835 mm
1	2	3	2605 mm
1		5	3125 mm
1		6	3640 mm
1	1	7	4410 mm

OZU-351

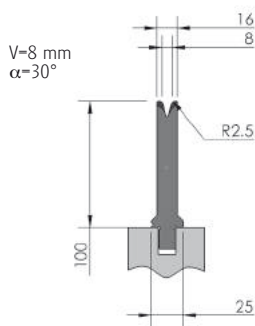

OZU-362

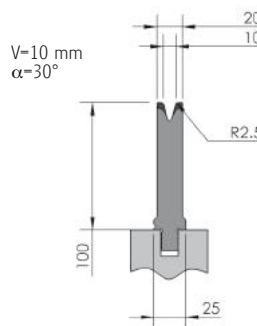

Type	Length	Weight kg	Max load
OZU-351/1	515 mm	7,7	80 t/m $\alpha=90^\circ$
OZU-351/2 ¹	550 mm - sectioned	8,3	
OZU-351/3 ¹	200 mm - sectioned	3,0	
OZU-351/6 ²	200 mm	3,0	
OZU-351/12	255 mm	3,6	

Type	Length	Weight kg	Max load
OZU-362/1	515 mm	9,1	80 t/m $\alpha=90^\circ$
OZU-362/2 ¹	550 mm - sectioned	9,7	
OZU-362/3 ¹	200 mm - sectioned	3,5	
OZU-362/6 ²	200 mm	3,5	
OZU-362/12	255 mm	4,3	

OZU-352

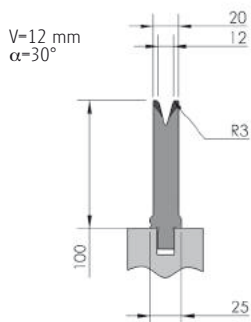

OZU-353

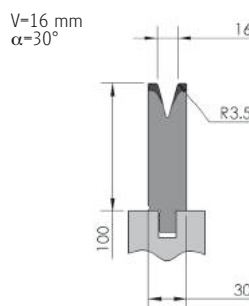

Type	Length	Weight kg	Max load
OZU-352/1	515 mm	9,0	80 t/m $\alpha=90^\circ$
OZU-352/2 ¹	550 mm - sectioned	9,6	
OZU-352/3 ¹	200 mm - sectioned	3,5	
OZU-352/6 ²	200 mm	3,5	
OZU-352/12	255 mm	4,2	

Type	Length	Weight kg	Max load
OZU-353/1	515 mm	12,5	80 t/m $\alpha=90^\circ$
OZU-E2M-353/1	515 mm	12,5	
OZU-353/2 ¹	550 mm - sectioned	13,3	
OZU-353/3 ¹	200 mm - sectioned	4,8	
OZU-353/6 ²	200 mm	4,8	
OZU-353/12	255 mm	5,9	

¹ Individual tool sections also available. ² /6 will be phased out.

ADAPTION

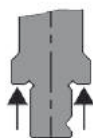

NS VI shoulder load with V-Lock®

E2M® SAFETY ROLLER BEARING: BOTTOM



E2M® bottom tools are provided with an internal lift system. This system is applicable for a tool weight with a maximum of 140 kg and minimum tool length of 200 mm. Minimum width of the tool should be 30 mm.

OZU-363

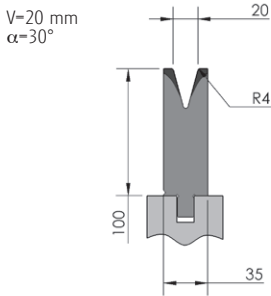

OZU-354

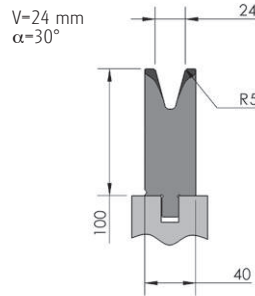

Type	Length	Weight kg	Max load
OZU-363/1	515 mm	14,0	80 t/m $\alpha=90^\circ$
OZU-E2M-363/1	515 mm	14,0	
OZU-363/2 ¹	550 mm - sectioned	15,0	
OZU-363/3 ¹	200 mm - sectioned	5,4	
OZU-363/6 ²	200 mm	5,4	
OZU-363/12	255 mm	6,7	

Type	Length	Weight kg	Max load
OZU-354/1	515 mm	15,5	80 t/m $\alpha=90^\circ$
OZU-E2M-354/1	515 mm	15,5	
OZU-354/2 ¹	550 mm - sectioned	16,6	
OZU-354/3 ¹	200 mm - sectioned	6,0	
OZU-354/6 ²	200 mm	6,0	
OZU-354/12	2550 mm	7,4	

OZU-330

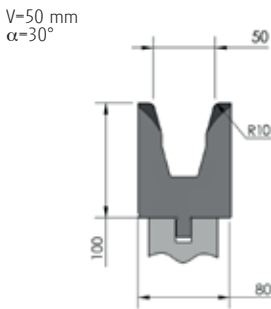

OZU-031

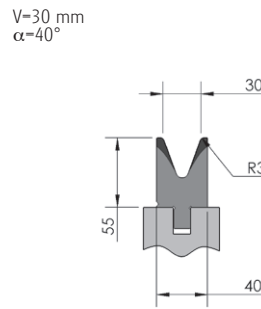

Type	Length	Weight kg	Max load
OZU-330/1	515 mm	24,5	150 t/m $\alpha=90^\circ$
OZU-E2M-330/1	515 mm	24,5	
OZU-330/2 ¹	550 mm - sectioned	26,2	
OZU-330/3 ¹	200 mm - sectioned	9,3	
OZU-330/12	200 mm	12,1	

Type	Length	Weight kg	Max load
OZU-031/1	515 mm	7,7	70 t/m $\alpha=90^\circ$
OZU-031/2 ¹	550 mm - sectioned	8,3	
OZU-031/3 ¹	200 mm - sectioned	3,0	
OZU-031/6 ²	200 mm	3,0	
OZU-031/12	255 mm	3,7	

¹ Individual tool sections also available. ² /6 will be phased out.

SEGMENTED TOOLING PROVIDES COMPLETE FLEXIBILITY

Create any desired tooling length from 20 mm to machine length in 5 mm increments by combining tool segments.

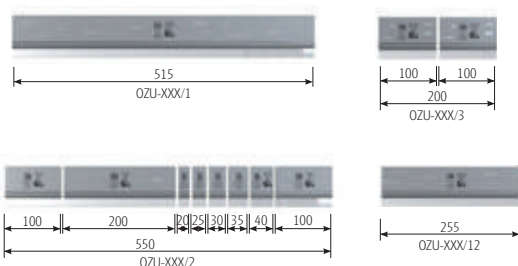

Examples of tool segments combined for various machine lengths			
550 mm segmented set	255 mm	515 mm	Total length
1	1	1	1320 mm
1	1	2	1835 mm
1	2	3	2605 mm
1		5	3125 mm
1		6	3640 mm
1	1	7	4410 mm

OZU-032

V=40 mm
α=40°

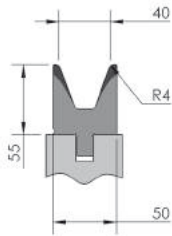

OZU-328

V=30 mm
α=40°

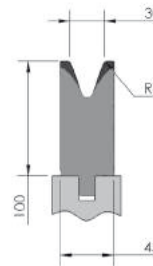

Type	Length	Weight kg	Max load
OZU-032/1	515 mm	8,8	80 t/m α=90°
OZU-032/2 ¹	550 mm - sectioned	9,4	
OZU-032/3 ¹	200 mm - sectioned	3,4	
OZU-032/6 ²	200 mm	3,4	
OZU-032/12	255 mm	4,1	

Type	Length	Weight kg	Max load
OZU-328/1	515 mm	17,0	100 t/m α=90°
OZU-E2M-328/1	515 mm	17,0	
OZU-328/2 ¹	550 mm - sectioned	18,2	
OZU-328/3 ¹	200 mm - sectioned	6,6	
OZU-328/6 ²	200 mm	6,6	
OZU-328/12	255 mm	8,2	

OZU-329

V=40 mm
α=40°

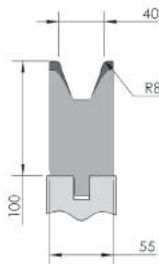

OZU-016

V=60 mm
α=60°

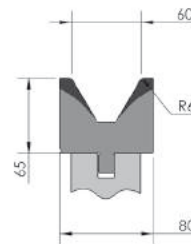

Type	Length	Weight kg	Max load
OZU-329/1	515 mm	19,3	125 t/m α=90°
OZU-E2M-329/1	515 mm	19,3	
OZU-329/2 ¹	550 mm - sectioned	20,6	
OZU-329/3 ¹	200 mm - sectioned	7,5	
OZU-329/6 ²	200 mm	7,5	
OZU-329/12	255 mm	9,5	

Type	Length	Weight kg	Max load
OZU-016/1	515 mm	16,5	160 t/m α=90°
OZU-E2M-016/1	515 mm	16,5	
OZU-016/2 ¹	550 mm - sectioned	17,6	
OZU-016/3 ¹	200 mm - sectioned	6,4	
OZU-016/6 ²	200 mm	6,4	
OZU-016/12	255 mm	7,9	

¹ Individual tool sections also available. ² /6 will be phased out.

ADAPTION

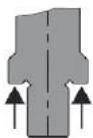

NS V shoulder load

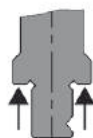

**NS VI shoulder load
V ≤ 60 mm with V-Lock®**

V-LOCK®

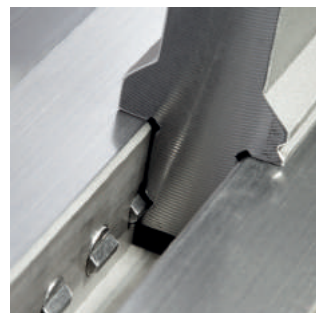

The V-Lock® improves the clamping and positioning of bottom tools. A groove in the tool tang allows specially designed clamping pins to automatically align and firmly clamp bottom tools in both X and Y directions.

All newly manufactured New Standard Crowning and Bottom Tool Holders with Hydraulic Clamping will be supplied with specially designed clamping pins to take advantage of the V-lock® feature.

OZU-327

V=60 mm
α=60°

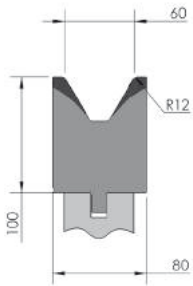

OZU-372

V=80 mm
α=60°

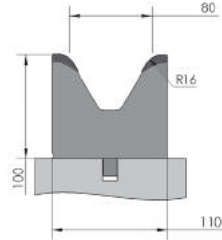

Type	Length	Weight	Max load
OZU-327/1	515 mm	27,9	160 t/m α=90°
OZU-E2M-327/1	515 mm	27,9	
OZU-327/2 ¹	550 mm - sectioned	29,8	
OZU-327/3 ¹	200 mm - sectioned	10,8	
OZU-327/6 ²	200 mm	10,8	
OZU-327/12	255 mm	13,5	

Type	Length	Weight kg	Max load
OZU-372/1	515 mm	34,3	220 t/m α=90°
OZU-E2M-372/1	515 mm	34,3	
OZU-372/12	255 mm	17,0	
OZU-E2M-372/12	255 mm	17,0	

OZU-373

V=100 mm
α=60°

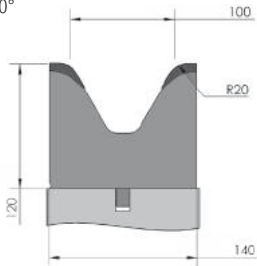

OZU-HD-374

V=120 mm
α=60°

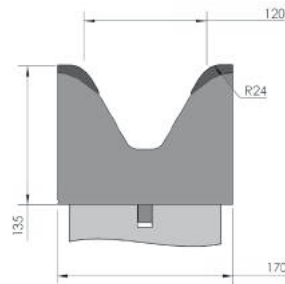

Type	Length	Weight kg	Max load
OZU-373/1	515 mm	51,7	250 t/m α=90°
OZU-E2M-373/1	515 mm	51,7	
OZU-373/12	255 mm	25,6	
OZU-E2M-373/12	255 mm	25,6	

Type	Length	Weight kg	Max load
OZU-HD-374/1	515 mm	69,1	270 t/m α=90°
OZU-HD-E2M-374/1	515 mm	69,1	
OZU-HD-374/12	255 mm	34,2	
OZU-HD-E2M-374/12	255 mm	34,2	

¹ Individual tool sections also available. ² /6 will be phased out.

SEGMENTED TOOLING PROVIDES COMPLETE FLEXIBILITY

Create any desired tooling length from 20 mm to machine length in 5 mm increments by combining tool segments.

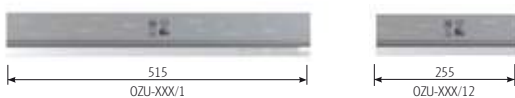

Examples of tool segments combined for various machine lengths		
255 mm	515 mm	Total length
1	2	1285 mm
1	3	1800 mm
2	4	2570 mm
	6	3090 mm
	7	3605 mm
2	8	4630 mm

OZU-HD-375

V=160 mm
α=60°

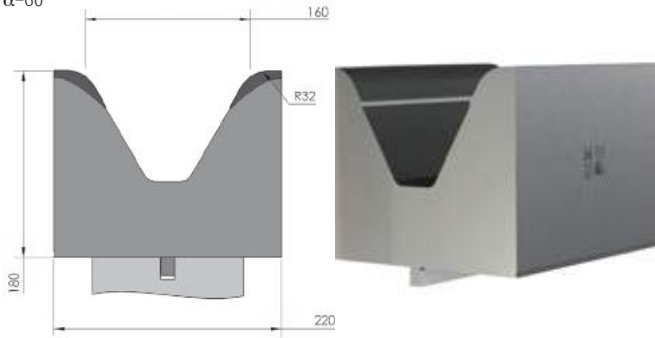

Type	Length	Weight kg	Max load
OZU-HD-375/1	515 mm	117,5	300 t/m α=90°
OZU-HD-E2M-375/1	515 mm	117,5	
OZU-HD-375/12	255 mm	58,2	
OZU-HD-E2M-375/12	255 mm	58,2	

OZU-HD-376

V=200 mm
α=60°

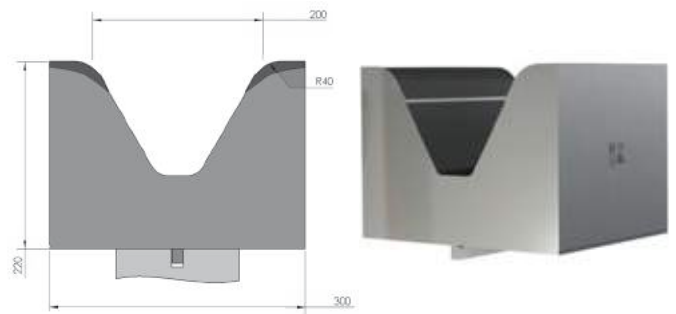

Type	Length	Weight kg	Max load
OZU-HD-376/12	255mm	98,9	350 t/m α=90°
OZU-HD-E2M-376/12	255 mm	98,9	

OZU-070

V=120 mm
α=70°

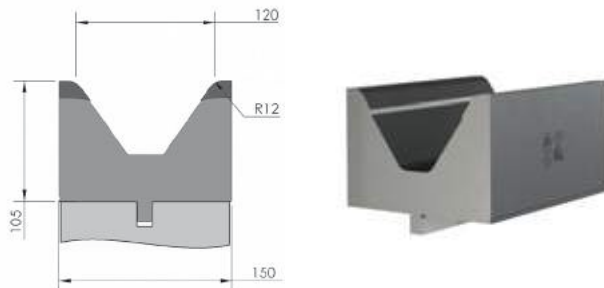

Type	Length	Weight kg	Max load
OZU-070/1	515 mm	45,5	250 t/m α=90°
OZU-E2M-070/1	515 mm	45,5	
OZU-070/12	255 mm	22,6	
OZU-E2M-070/12	255 mm	22,6	

OZU-071

V=160 mm
α=70°

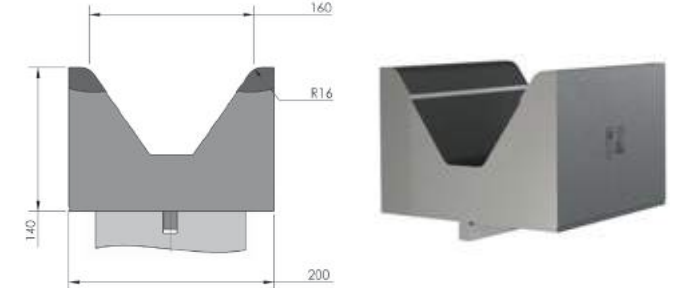

Type	Length	Weight kg	Max load
OZU-071/1	515 mm	79,2	250 t/m α=90°
OZU-E2M-071/1	515 mm	79,2	
OZU-071/12	255 mm	39,3	
OZU-E2M-071/12	255 mm	39,3	

ADAPTION

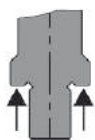

NS V shoulder load

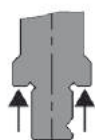

NS VI shoulder load
V ≤ 60 mm with V-Lock®

EYE BOLTS



New Standard type OZU-HD bottom tools feature standard tapped threaded holes for eye bolts. These eye bolts (not included) make it easier to handle and change safely heavy bottom dies.

OZU-013

V=24 mm
α=80°

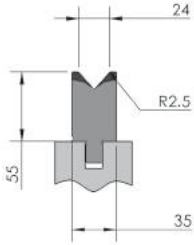

OZU-014

V=30 mm
α=80°

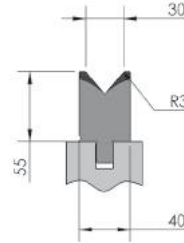

Type	Length	Weight kg	Max load
OZU-013/1	515 mm	8,2	125 t/m α=90°
OZU-013/2 ¹	550 mm - sectioned	8,8	
OZU-013/3 ¹	200 mm - sectioned	3,2	
OZU-013/6 ²	200 mm	3,2	
OZU-013/12	255 mm	3,9	

Type	Length	Weight kg	Max load
OZU-014/1	515 mm	8,8	125 t/m α=90°
OZU-014/2 ¹	550 mm - sectioned	9,4	
OZU-014/3 ¹	200 mm - sectioned	3,4	
OZU-014/6 ²	200 mm	3,4	
OZU-014/12	255 mm	4,3	

OZU-015

V=40 mm
α=80°

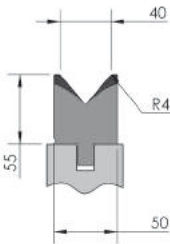

OZU-035

V=50 mm
α=80°

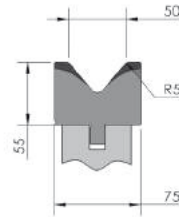

Type	Length	Weight kg	Max load
OZU-015/1	515 mm	10,8	125 t/m α=90°
OZU-015/2 ¹	550 mm - sectioned	11,6	
OZU-015/3 ¹	200 mm - sectioned	4,2	
OZU-015/6 ²	200 mm	4,2	
OZU-015/12	255 mm	9,6	

Type	Length	Weight kg	Max load
OZU-035/1	515 mm	14,9	150 t/m α=90°
OZU-E2M-035/1	515 mm	14,9	
OZU-035/2 ¹	550 mm - sectioned	16,0	
OZU-035/3 ¹	200 mm - sectioned	5,8	
OZU-035/6 ²	200 mm	5,8	
OZU-035/12	255 mm	7,2	

¹ Individual tool sections also available. ² /6 will be phased out.

SEGMENTED TOOLING PROVIDES COMPLETE FLEXIBILITY

Create any desired tooling length from 20 mm to machine length in 5 mm increments by combining tool segments.

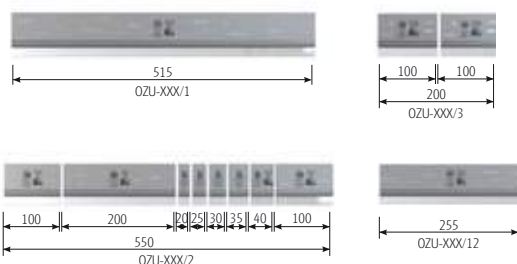

Examples of tool segments combined for various machine lengths			
550 mm segmented set	255 mm	515 mm	Total length
1	1	1	1320 mm
1	1	2	1835 mm
1	2	3	2605 mm
1		5	3125 mm
1		6	3640 mm
1	1	7	4410 mm

OZU-017

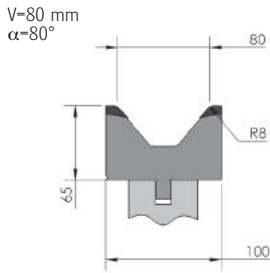

OZU-018

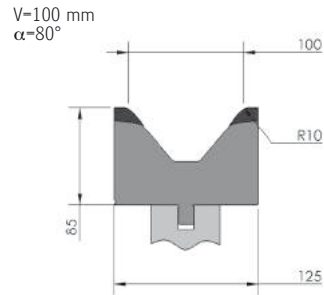

Type	Length	Weight kg	Max load
OZU-017/1	515 mm	19,8	150 t/m $\alpha=90^\circ$
OZU-E2M-017/1	515 mm	19,8	
OZU-017/12	255 mm	9,8	

Type	Length	Weight kg	Max load
OZU-018/1	515 mm	32,2	150 t/m $\alpha=90^\circ$
OZU-E2M-018/1	515 mm	32,2	
OZU-018/12	255 mm	15,9	
OZU-E2M-018/12	255 mm	15,9	

OZU-313

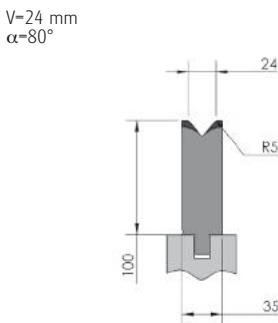

OZU-324

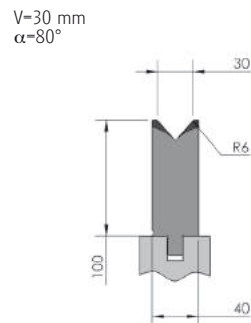

Type	Length	Weight kg	Max load
OZU-313/1	515 mm	13,6	125 t/m $\alpha=90^\circ$
OZU-E2M-313/1	515 mm	13,6	
OZU-313/2 ¹	550 mm - sectioned	14,6	
OZU-313/3 ¹	200 mm - sectioned	5,3	
OZU-313/6 ²	200 mm	5,3	
OZU-313/12	255 mm	7,1	

Type	Length	Weight kg	Max load
OZU-324/1	515 mm	16,5	125 t/m $\alpha=90^\circ$
OZU-E2M-324/1	515 mm	16,5	
OZU-324/2 ¹	550 mm - sectioned	17,7	
OZU-324/3 ¹	200 mm - sectioned	6,4	
OZU-324/6 ²	200 mm	6,4	
OZU-324/12	255 mm	7,9	

¹ Individual tool sections also available. ² /6 will be phased out.

ADAPTION

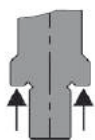

NS V shoulder load

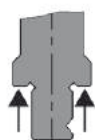

NS VI shoulder load
V ≤ 60 mm with V-Lock®

SHOULDER RADII

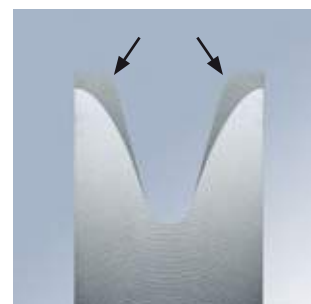

New Standard Bottom Tools in the OZU-3** and OZU-4** series feature extra large shoulder radii (R = approx 20% of V-opening) which greatly reduce part marking during the bending process.

OZU-325

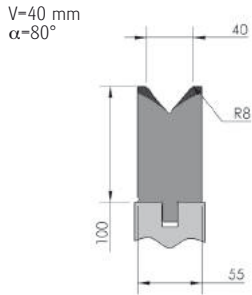

OZU-326

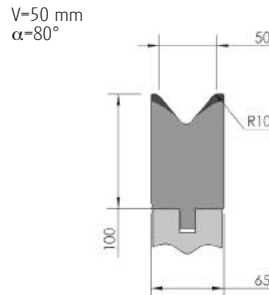

Type	Length	Weight	Max load
OZU-325/1	515 mm	21,6	125 t/m $\alpha=90^\circ$
OZU-E2M-325/1	515 mm	21,6	
OZU-325/2 ¹	550 mm - sectioned	23,0	
OZU-325/3 ¹	200 mm - sectioned	8,4	
OZU-325/6 ²	200 mm	8,4	
OZU-325/12	255 mm	10,5	

Type	Length	Weight kg	Max load
OZU-326/1	515 mm	24,6	150 t/m $\alpha=90^\circ$
OZU-E2M-326/1	515 mm	24,6	
OZU-326/2 ¹	550 mm - sectioned	26,3	
OZU-326/3 ¹	200 mm - sectioned	9,6	
OZU-326/6 ²	200 mm	9,6	
OZU-326/12	255 mm	11,9	

OZU-317

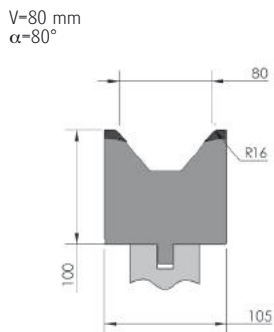

OZU-318

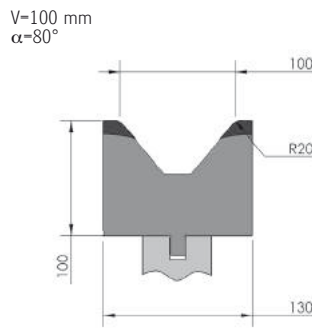

Type	Length	Weight kg	Max load
OZU-317/1	515 mm	36,4	150 t/m $\alpha=90^\circ$
OZU-E2M-317/1	515 mm	36,4	
OZU-317/12	255 mm	18,0	
OZU-E2M-317/12	255 mm	18,0	

Type	Length	Weight kg	Max load
OZU-318/1	515 mm	42,0	150 t/m $\alpha=90^\circ$
OZU-E2M-318/1	515 mm	42,0	
OZU-318/12	255 mm	20,8	
OZU-E2M-318/12	255 mm	20,8	

¹ Individual tool sections also available. ² /6 will be phased out.

SEGMENTED TOOLING PROVIDES COMPLETE FLEXIBILITY

Create any desired tooling length from 20 mm to machine length in 5 mm increments by combining tool segments.



Examples of tool segments combined for various machine lengths			
550 mm segmented set	255 mm	515 mm	Total length
1	1	1	1320 mm
1	1	2	1835 mm
1	2	3	2605 mm
1		5	3125 mm
1		6	3640 mm
1	1	7	4410 mm

OZU-024

V=4 mm
α=86°

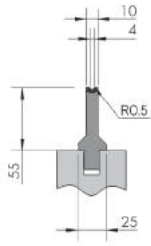

OZU-021

V=6 mm
α=86°

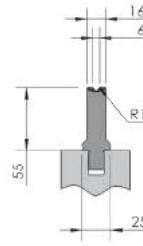

Type	Length	Weight kg	Max load
OZU-024/1	515 mm	3,5	45 t/m
OZU-024/2 ¹	550 mm - sectioned	3,7	
OZU-024/3 ¹	200 mm - sectioned	1,4	
OZU-024/6 ²	200 mm	1,4	
OZU-024/12	255 mm	2,3	

Type	Length	Weight kg	Max load
OZU-021/1	515 mm	4,9	120 t/m
OZU-021/2 ¹	550 mm - sectioned	5,2	
OZU-021/3 ¹	200 mm - sectioned	1,9	
OZU-021/6 ²	200 mm	1,9	
OZU-021/12	255 mm	2,3	

OZU-010

V=8 mm
α=86°

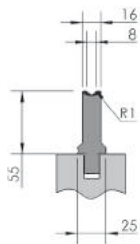

OZU-022

V=10 mm
α=86°

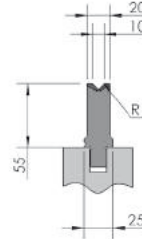

Type	Length	Weight kg	Max load
OZU-010/1	515 mm	4,9	120 t/m
OZU-010/2 ¹	550 mm - sectioned	5,2	
OZU-010/3 ¹	200 mm - sectioned	1,9	
OZU-010/6 ²	200 mm	1,9	
OZU-010/12	255 mm	2,3	

Type	Length	Weight kg	Max load
OZU-022/1	515 mm	5,7	120 t/m
OZU-022/2 ¹	550 mm - sectioned	6,1	
OZU-022/3 ¹	200 mm - sectioned	2,2	
OZU-022/6 ²	200 mm	2,2	
OZU-022/12	255 mm	2,7	

¹ Individual tool sections also available. ² /6 will be phased out.

ADAPTION

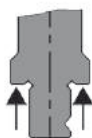

**NS VI shoulder load
with V-Lock®**

SMART TOOLING



All WILA New Standard Premium tools have a unique DM-code. With the WILA Smart Tooling app you can scan all the tools. After scanning the DM-code you have immediate access to the tool's specifications and the correct tool data files for your press brake control.



OZU-011

V=12 mm
α=86°

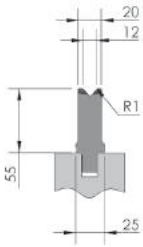

OZU-012

V=16 mm
α=86°

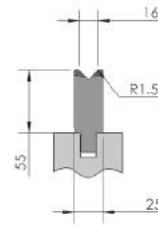

Type	Length	Weight kg	Max load
OZU-011/1	515 mm	5,7	120 t/m
OZU-011/2 ¹	550 mm - sectioned	6,1	
OZU-011/3 ¹	200 mm - sectioned	2,2	
OZU-011/6 ²	200 mm	2,2	
OZU-011/12	255 mm	2,6	

Type	Length	Weight kg	Max load
OZU-012/1	515 mm	6,7	120 t/m
OZU-012/2 ¹	550 mm - sectioned	7,2	
OZU-012/3 ¹	200 mm - sectioned	2,6	
OZU-012/6 ²	200 mm	2,6	
OZU-012/12	255 mm	3,0	

OZU-023

V=20 mm
α=86°

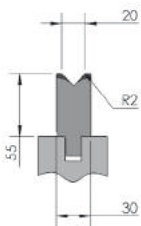

OZU-336

V=4 mm
α=86°

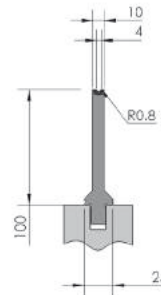

Type	Length	Weight kg	Max load
OZU-023/1	515 mm	7,7	120 t/m
OZU-023/2 ¹	550 mm - sectioned	8,3	
OZU-023/3 ¹	200 mm - sectioned	3,0	
OZU-023/6 ²	200 mm	3,0	
OZU-023/12	255 mm	3,5	

Type	Length	Weight kg	Max load
OZU-336/1	515 mm	5,1	45 t/m
OZU-336/2 ¹	550 mm - sectioned	5,5	
OZU-336/3 ¹	200 mm - sectioned	2,0	
OZU-336/6 ²	200 mm	2,0	
OZU-336/12	255 mm	3,5	

¹ Individual tool sections also available. ² /6 will be phased out.

SEGMENTED TOOLING PROVIDES COMPLETE FLEXIBILITY

Create any desired tooling length from 20 mm to machine length in 5 mm increments by combining tool segments.

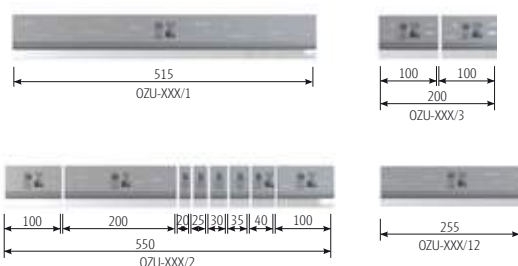

Examples of tool segments combined for various machine lengths			
550 mm segmented set	255 mm	515 mm	Total length
1	1	1	1320 mm
1	1	2	1835 mm
1	2	3	2605 mm
1		5	3125 mm
1		6	3640 mm
1	1	7	4410 mm

OZU-321

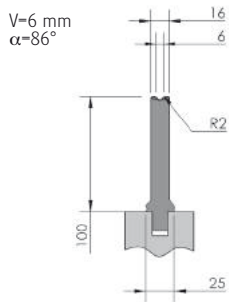

OZU-310

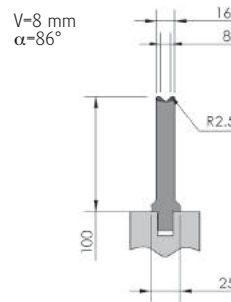

Type	Length	Weight kg	Max load
OZU-321/1	515 mm	7,8	120 t/m
OZU-321/2 ¹	550 mm - sectioned	8,3	
OZU-321/3 ¹	200 mm - sectioned	3,0	
OZU-321/6 ²	200 mm	3,0	
OZU-321/12	255 mm	3,7	

Type	Length	Weight kg	Max load
OZU-310/1	515 mm	7,8	120 t/m
OZU-310/2 ¹	550 mm - sectioned	8,3	
OZU-310/3 ¹	200 mm - sectioned	3,0	
OZU-310/6 ²	200 mm	3,0	
OZU-310/12	255 mm	3,7	

OZU-322

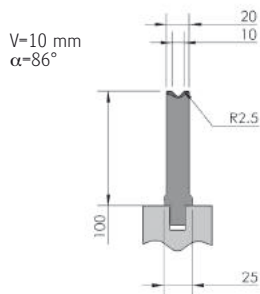

OZU-311

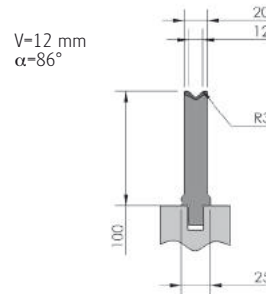

Type	Length	Weight kg	Max load
OZU-322/1	515 mm	9,2	120 t/m
OZU-322/2 ¹	550 mm - sectioned	9,8	
OZU-322/3 ¹	200 mm - sectioned	3,6	
OZU-322/6 ²	200 mm	3,6	
OZU-322/12	255 mm	4,5	

Type	Length	Weight kg	Max load
OZU-311/1	515 mm	9,2	120 t/m
OZU-311/2 ¹	550 mm - sectioned	9,8	
OZU-311/3 ¹	200 mm - sectioned	3,6	
OZU-311/6 ²	200 mm	3,6	
OZU-311/12	255 mm	4,4	

¹ Individual tool sections also available. ² /6 will be phased out.

ADAPTION

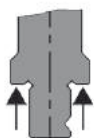

NS VI shoulder load with V-Lock®

TOOL ADVISOR



This high-end engineering tool allows you to make a decision online about which press brake tools are best suited to your specific bending needs. If the required tool is unavailable as a standard solution, it is possible to immediately design a special tool and order it via the WILA Webshop.

OZU-312

V=16 mm
α=86°

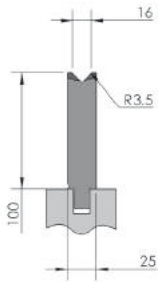

OZU-323

V=20 mm
α=86°

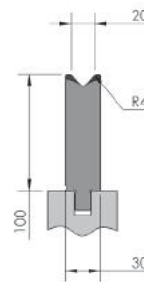

Type	Length	Weight kg	Max load
OZU-312/1	515 mm	9,9	120 t/m
OZU-312/2 ¹	550 mm - sectioned	10,6	
OZU-312/3 ¹	200 mm - sectioned	3,9	
OZU-312/6 ²	200 mm	3,9	
OZU-312/12	255 mm	5,3	

Type	Length	Weight kg	Max load
OZU-323/1	515 mm	12,8	120 t/m
OZU-E2M-323/1	515 mm	12,8	
OZU-323/2 ¹	550 mm - sectioned	13,7	
OZU-323/3 ¹	200 mm - sectioned	5,0	
OZU-323/6 ²	200 mm	5,0	
OZU-323/12	255 mm	6,2	

OZU-041

V=6 mm
α=90°

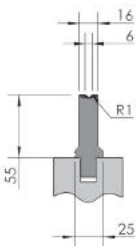

OZU-042

V=8 mm
α=90°

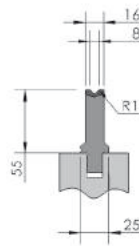

Type	Length	Weight kg	Max load
OZU-041/1	515 mm	4,9	120 t/m
OZU-041/2 ¹	550 mm - sectioned	5,2	
OZU-041/3 ¹	200 mm - sectioned	1,9	
OZU-041/6 ²	200 mm	1,9	
OZU-041/12	255 mm	2,3	

Type	Length	Weight kg	Max load
OZU-042/1	515 mm	4,9	120 t/m
OZU-042/2 ¹	550 mm - sectioned	5,2	
OZU-042/3 ¹	200 mm - sectioned	1,9	
OZU-042/6 ²	200 mm	1,9	
OZU-042/12	255 mm	2,3	

¹ Individual tool sections also available. ² /6 will be phased out.

SEGMENTED TOOLING PROVIDES COMPLETE FLEXIBILITY

Create any desired tooling length from 20 mm to machine length in 5 mm increments by combining tool segments.

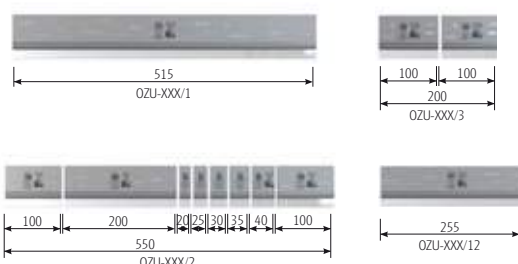

Examples of tool segments combined for various machine lengths			
550 mm segmented set	255 mm	515 mm	Total length
1	1	1	1320 mm
1	1	2	1835 mm
1	2	3	2605 mm
1		5	3125 mm
1		6	3640 mm
1	1	7	4410 mm

OZU-043

V=10 mm
α=90°

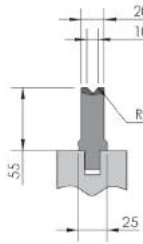

OZU-044

V=12 mm
α=90°

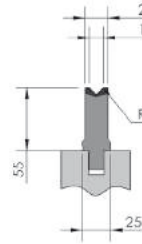

Type	Length	Weight kg	Max load
OZU-043/1	515 mm	5,7	120 t/m
OZU-043/2 ¹	550 mm - sectioned	6,1	
OZU-043/3 ¹	200 mm - sectioned	2,2	
OZU-043/6 ²	200 mm	2,2	
OZU-043/12	255 mm	2,7	

Type	Length	Weight kg	Max load
OZU-044/1	515 mm	5,7	120 t/m
OZU-044/2 ¹	550 mm - sectioned	6,1	
OZU-044/3 ¹	200 mm - sectioned	2,2	
OZU-044/6 ²	200 mm	2,2	
OZU-044/12	255 mm	2,6	

OZU-045

V=16 mm
α=90°

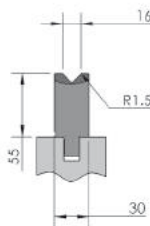

OZU-341

V=6 mm
α=90°

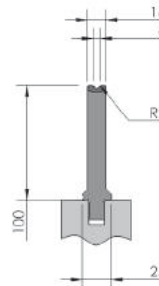

Type	Length	Weight kg	Max load
OZU-045/1	515 mm	7,7	120 t/m
OZU-045/2 ¹	550 mm - sectioned	8,3	
OZU-045/3 ¹	200 mm - sectioned	3,0	
OZU-045/6 ²	200 mm	3,0	
OZU-045/12	255 mm	3,6	

Type	Length	Weight kg	Max load
OZU-341/1	515 mm	7,8	120 t/m
OZU-341/2 ¹	550 mm - sectioned	8,3	
OZU-341/3 ¹	200 mm - sectioned	3,0	
OZU-341/6 ²	200 mm	3,0	
OZU-341/12	255 mm	3,7	

¹ Individual tool sections also available. ² /6 will be phased out.

ADAPTION

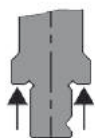

**NS VI shoulder load
with V-Lock®**

OZU-ZN COATING FOR GALVANIZED MATERIAL



“Bending instead of cleaning!” OZU-ZN tools feature a coating that has been specially developed by WILA for use with galvanized material. This coating is applied to CNC-Deephardened® bottom tools and prevents zinc deposits from building on the bending radii.

OZU-342

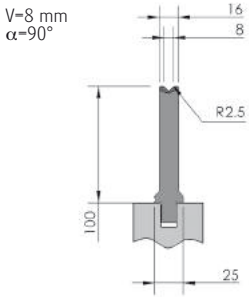

OZU-343

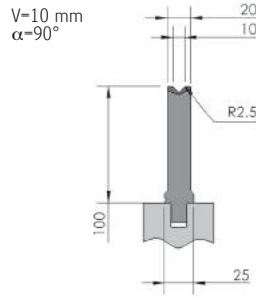

Type	Length	Weight kg	Max load
OZU-342/1	515 mm	7,8	120 t/m
OZU-342/2 ¹	550 mm - sectioned	8,3	
OZU-342/3 ¹	200 mm - sectioned	3,0	
OZU-342/6 ²	200 mm	3,0	
OZU-342/12	255 mm	3,7	

Type	Length	Weight kg	Max load
OZU-343/1	515 mm	9,2	120 t/m
OZU-343/2 ¹	550 mm - sectioned	9,8	
OZU-343/3 ¹	200 mm - sectioned	3,6	
OZU-343/6 ²	200 mm	3,6	
OZU-343/12	255 mm	4,5	

OZU-344

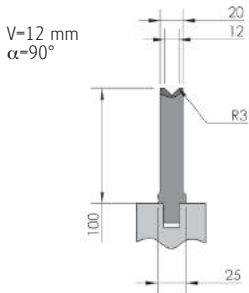

OZU-345

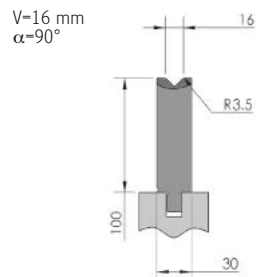

Type	Length	Weight kg	Max load
OZU-344/1	515 mm	9,2	120 t/m
OZU-344/2 ¹	550 mm - sectioned	9,8	
OZU-344/3 ¹	200 mm - sectioned	3,6	
OZU-344/6 ²	200 mm	3,6	
OZU-344/12	255 mm	4,4	

Type	Length	Weight kg	Max load
OZU-345/1	515 mm	12,7	120 t/m
OZU-E2M-345/1	515 mm	12,7	
OZU-345/2 ¹	550 mm - sectioned	13,5	
OZU-345/3 ¹	200 mm - sectioned	4,9	
OZU-345/6 ²	200 mm	4,9	
OZU-345/12	255 mm	6,3	

¹ Individual tool sections also available. ² /6 will be phased out.

SEGMENTED TOOLING PROVIDES COMPLETE FLEXIBILITY

Create any desired tooling length from 20 mm to machine length in 5 mm increments by combining tool segments.

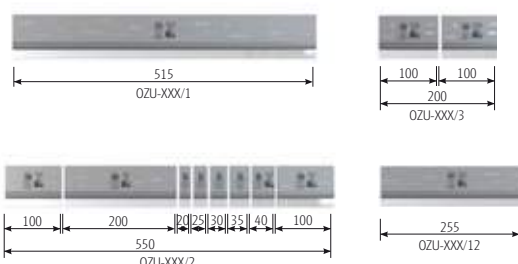

Examples of tool segments combined for various machine lengths			
550 mm segmented set	255 mm	515 mm	Total length
1	1	1	1320 mm
1	1	2	1835 mm
1	2	3	2605 mm
1		5	3125 mm
1		6	3640 mm
1	1	7	4410 mm

OZU-346

V=20 mm
α=90°

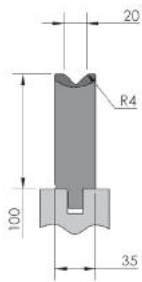

Type	Length	Weight kg	Max load
OZU-346/1	515 mm	14,8	120 t/m
OZU-E2M-346/1	515 mm	14,8	
OZU-346/2 ¹	550 mm - sectioned	15,8	
OZU-346/3 ¹	200 mm - sectioned	5,7	
OZU-346/6 ²	200 mm	5,7	
OZU-346/12	255 mm	7,2	

¹ Individual tool sections also available. ² /6 will be phased out.

WILA ROTABEND®

WILA prides itself on producing the finest quality and highest precision press brake tooling, and it makes no exception with its new line of rotating v dies, RotaBend. With tight tolerances and CNC Deephardened contact surfaces and rotor wings, you can now easily bend short flanges and reduce part marking without sacrificing the WILA quality and precision you've come to expect.

WILA RotaBend includes replaceable built-in inserts that rotate to enable forming of short or tapered flanges.

Advantages of WILA RotaBend:

- Eliminates distortion at holes near the bend line.
- Reduces part marking.
- Forms very tight inside radius when required.
- Rotor wings and contact surface of the body are hardened, ensuring long term durability and accuracy.
- Rotor wings are very easy to disassemble and clean.
- Machined to extremely tight tolerances for ultimate precision.
- Narrow tool design for down flange bending freedom.
- Suitable for bending various material thicknesses.
- Can be combined with OM tools for bending 90° angles.



	OZU-WRB-301	OZU-WRB-302	OZU-WRB-303
Max. material thickness	2 mm	3 mm	5 mm
Center distance of two rotors (wing rotor opening)	8.9 mm	12.9 mm	26.3 mm
Max. applicable tip radius of the top tool	2.4 mm	3 mm	6 mm
Min. outside flange length*	5.2 mm (S=1mm)	6.5 mm (S=1 mm)	15.5 mm (S=2 mm)
Return bend (outside dimension)	14.4 mm (S=1mm)	20 mm (S=1 mm)	35 mm (S=2 mm)
Min. bend angle**	40°	40-60° (40° max. S=2 mm)	60° (max. S=4 mm)
Hardness of wing rotor (see below in blue)	56-60 HRC	56-60 HRC	56-60 HRC
Hardness of body contact surface (see below in red)	52-54 HRC	52-54 HRC	52-54 HRC
Working height***	100 mm	100 mm	100 mm
Bottom adaption width	13 mm	13 mm	13 mm
Tonnage capacity	100 t/m	130 t/m	200 t/m
Available lengths	515 mm	515 mm	515 mm
	550 mm sectioned	550 mm sectioned	200 mm
	200 mm	200 mm	100 - 100 mm
	100 - 100 mm	100 - 100 mm	

* These dimensions are outside dimensions and apply to bending mild steel at 90°. Dimensions can change with stainless steel and aluminum.

** Minimum bend angle may vary depending material and punch radius.

*** Can be combined with OM tools for bending 90° angles.

OZU-WRB-301

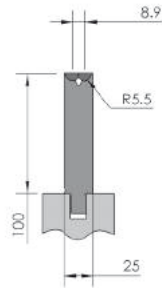

OZU-WRB-302

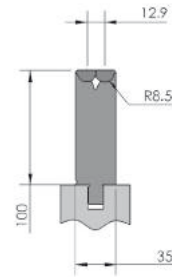

Type	Length	Weight kg	Max load
OZU-WRB-301/1	515 mm	9,3	100 t/m
OZU-WRB-301/2	550 mm - sectioned	9,9	
OZU-WRB-301/3	200 mm - sectioned	3,6	
OZU-WRB-301/6	200 mm	3,6	

Type	Length	Weight kg	Max load
OZU-WRB-302/1	515mm	11,1	130 t/m
OZU-WRB-302/2	550mm - sectioned	11,8	
OZU-WRB-302/3	200mm - sectioned	4,3	
OZU-WRB-302/6	200mm	4,3	

OZU-WRB-303

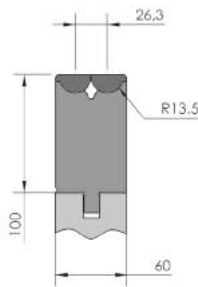

Type	Length	Weight kg	Max load
OZU-WRB-303/1	515mm	18,6	200 t/m
OZU-WRB-303/3	200mm - sectioned	7,2	
OZU-WRB-303/6	200mm	7,2	

ADAPTION

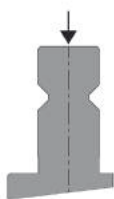

NS I head load

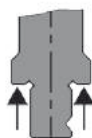

NS VI shoulder load with V-Lock®

WEBSHOP



The WILA Webshop features a comprehensive overview of WILA's top and bottom tools. The Webshop can be used to request quotes, check prices, find delivery times, and place orders directly or through your preferred ASP. Create your account via: www.wilatooling.com

BIU-401

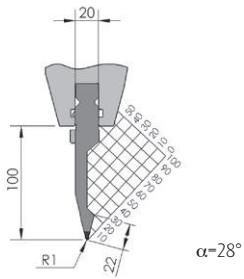

BIU-403

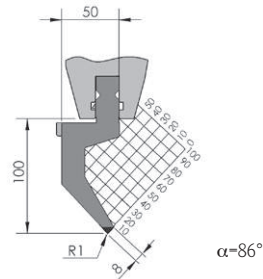

Type	Length	Weight kg	Max load
BIU-401/1	515 mm	7,3	65 t/m
BIU-401/10 ¹	475 mm - sectioned	6,7	
BIU-401/11 ¹	200 mm - sectioned	2,4	

Type	Length	Weight kg	Max load
BIU-403/1	515 mm	12,3	60 t/m
BIU-403/10 ¹	475 mm - sectioned	11,4	
BIU-403/11 ¹	200 mm - sectioned	3,9	

BIU-404

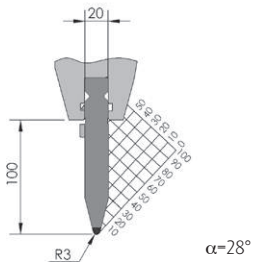

Type	Length	Weight kg	Max load
BIU-404/1	515 mm	10,1	100 t/m
BIU-404/10 ¹	475 mm - sectioned	9,3	
BIU-404/11 ¹	200 mm - sectioned	3,2	

¹ Individual tool sections also available.

SEGMENTED TOOLING PROVIDES COMPLETE FLEXIBILITY

Create any desired tooling length from 20 mm to machine length in 5 mm increments by combining tool segments.

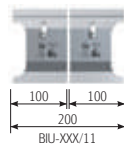
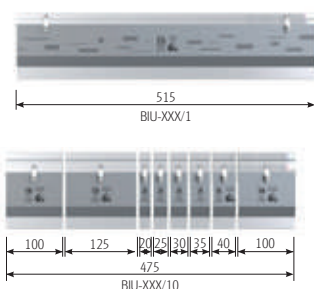

Examples of tool segments combined for various machine lengths			
475 mm segmented set	200 mm	515 mm	Total length
1	1	1	1190 mm
1	1	2	1705 mm
1	2	3	2420 mm
1		5	3050 mm
1		6	3165 mm
1	1	7	4580 mm

OZU-401

V=8 mm
α=30°

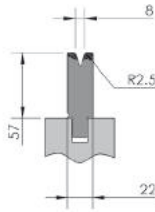

OZU-402

V=10 mm
α=30°

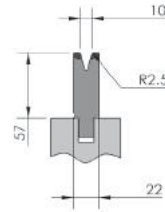

Type	Length	Weight kg	Max load
OZU-401/1	515 mm	5,7	60 t/m α=90°
OZU-401/10 ¹	475 mm - sectioned	5,2	
OZU-401/3 ¹	200 mm - sectioned	2,2	

Type	Length	Weight kg	Max load
OZU-402/1	515 mm	5,6	60 t/m α=90°
OZU-402/10 ¹	475 mm - sectioned	5,1	
OZU-402/3 ¹	200 mm - sectioned	2,2	

OZU-403

V=12 mm
α=30°

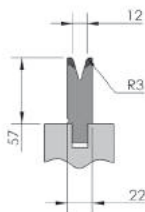

OZU-404

V=16 mm
α=30°

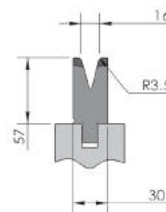

Type	Length	Weight kg	Max load
OZU-403/1	515 mm	5,4	60 t/m α=90°
OZU-403/10 ¹	475 mm - sectioned	5,0	
OZU-403/3 ¹	200 mm - sectioned	2,1	

Type	Length	Weight kg	Max load
OZU-404/1	515 mm	6,8	60 t/m α=90°
OZU-404/10 ¹	475 mm - sectioned	6,3	
OZU-404/3 ¹	200 mm - sectioned	2,7	

¹ Individual tool sections also available.

ADAPTION

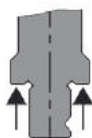

**NS VI shoulder load
with V-Lock®**

SMART TOOLING



All WILA New Standard Premium tools have a unique DM-code. With the WILA Smart Tooling app you can scan all the tools. After scanning the DM-code you have immediate access to the tool's specifications and the correct tool data files for your press brake control.



OZU-405

V=24 mm
α=30°

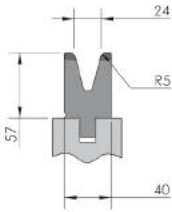

Type	Length	Weight kg	Max load
OZU-405/1	515 mm	8,1	60 t/m α=90°
OZU-405/10 ¹	475 mm - sectioned	7,5	
OZU-405/3 ¹	200 mm - sectioned	3,2	

OZU-406

V=30 mm
α=40°

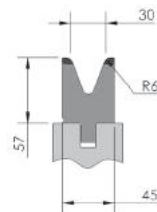

Type	Length	Weight kg	Max load
OZU-406/1	515 mm	8,9	70 t/m α=90°
OZU-406/10 ¹	475 mm - sectioned	8,2	
OZU-406/3 ¹	200 mm - sectioned	3,5	

OZU-407

V=40 mm
α=40°

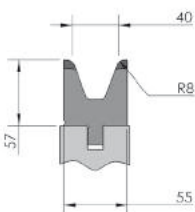

Type	Length	Weight kg	Max load
OZU-407/1	515 mm	9,7	80 t/m α=90°
OZU-407/10 ¹	475 mm - sectioned	8,9	
OZU-407/3 ¹	200 mm - sectioned	3,8	

OZU-408

V=50 mm
α=60°

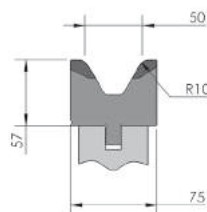

Type	Length	Weight kg	Max load
OZU-408/1	515 mm	14,2	100 t/m α=90°
OZU-408/10 ¹	475 mm - sectioned	13,1	
OZU-408/3 ¹	200 mm - sectioned	5,5	

¹ Individual tool sections also available.

SEGMENTED TOOLING PROVIDES COMPLETE FLEXIBILITY

Create any desired tooling length from 20 mm to machine length in 5 mm increments by combining tool segments.

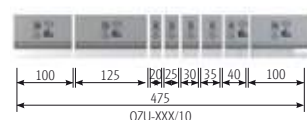
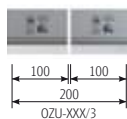

Examples of tool segments combined for various machine lengths			
475 mm segmented set	200 mm	515 mm	Total length
1	1	1	1190 mm
1	1	2	1705 mm
1	2	3	2420 mm
1		5	3050 mm
1		6	3165 mm
1	1	7	4580 mm

CUSTOM MADE TOOLING

Aside from the standard tools and accessories, we can supply Custom Made tools which can be manufactured completely according to the customer's needs. These tools can be made in any of the tooling style executions and to the specific length required, as well as with different methods of hardening.

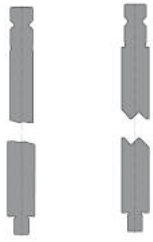

Offset Tooling

It is also possible to segment the tools into the lengths desired by the customer, to allow, for example, the bending of box-shaped products. For top tools it is possible to provide tooling sets including horn sections (sections with a cut-out to accommodate parts with a reverse flange).

A number of possibilities are on this page.

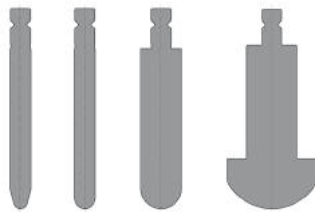

Radius Tooling



Horn



Box Bending



Heavy Duty



Radius Bending



Special Application

TOOLING

ADJUSTABLE BOTTOM TOOLS (MVM AND MULTI-V)

Custom Made Tooling also include bottom tools with an adjustable opening width. The opening width (V-opening) can be adjusted as necessary (Fig. 4.1). The primary advantage offered by these adjustable bottom tools is that the bottom tool does not need to be changed with the sheet thickness: the opening width can simply be adjusted as necessary. This results in substantial time savings especially when large dimensions are involved.

The WILA range of products includes two models of adjustable bottom tools:

- Automatically adjustable bottom tool, type MVM, designed for bending precision sheet material
- Manually adjustable bottom tool, type Multi-V, designed for bending plate material

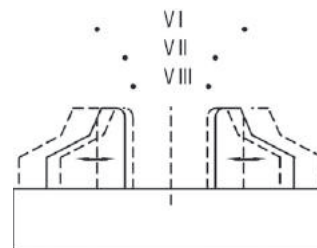

Fig. 4.1

Multi-V-MATIC (MVM).



Multi-V.



MULTI-V-MATIC (MVM)

The automatically adjustable bottom tool MVM Type I.1 offers a number of specific advantages. Thanks to the interval-free adjustment possibilities, the optimum V-opening can always be selected. Changing the V-opening is ultra-fast as there are no bottom tools to change out and no spacer bars are required. The V-opening can be changed using a CNC Drive Motor which can be tied into the press brake control allowing the V-opening to be programmed in automatically. Or the MVM can be supplied with a manual hand crank assembly and digital counter to select and display the desired V-opening. Thanks to the compact construction, the user has optimum bending freedom. Moreover, the construction is extremely stable because it was designed based on the vise principle. It is even possible to combine the system with a hemming tool (e.g. type BIU-051) to pre-bend and to flatten. At the same time, the MVM can be used as a tool holder for other bottom tools with a 13 mm adaption, for example OZU bottom tools from the New Standard or American Style programs.

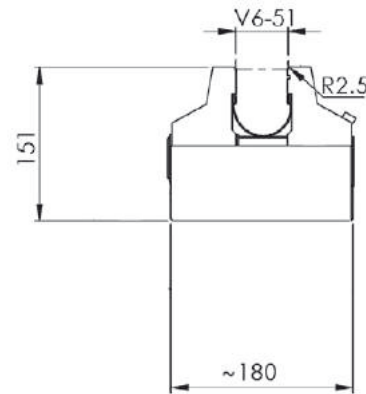

Pre-bend and flattening in the same tool.

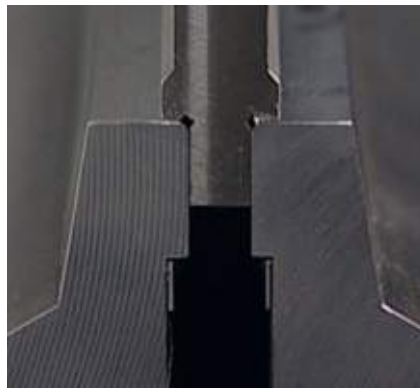

Acts as a tool holder for OZU bottom tools.



MVM Type I-1.

MVM I.1 CENTRALLY ADJUSTABLE BOTTOM TOOL		
V-opening continuously adjustable from 6-51 mm.		
Delivery	Standard	Optional
CNC drive unit	●	
Manual adjustment with digital read-out		○
No tool changes required	●	
Always the ideal V-opening	●	
Bending radii are CNC-Deephardened®	●	
Pre-bend and flattening in the same tool	●	
Will act as tool holder for OZU-tooling	●	
Practically Unlimited bend angles (e.g. 30° at S=6 mm)	●	

Length mm	Weight kg	Max load
1785	179	100 t/m α= 90°
2040	204	
2380	238	
2550	255	
3060	306	
3655	366	
4080	408	
4250	425	
4845	481	
6120	601	

Note: Other lengths available on request.

MULTI-V

The fully modular adjustable bottom tool type Multi-V offers a number of advantages. The Multi-V main structure is simple; it consists of multiple elements of the same type which are built together into one tool. In case of damage it is simple and cost effective to replace one or more modules. It is possible to quickly change the desired V-openings by sliding in spacer bars on the front and rear side of the saddle and then lock the Multi-V section in place with two set screws. The spacer bars can be supplied by us or procured locally by the customer. This gives you the possibility to choose the V-opening that best fits the characteristics of the material to be processed; this is particularly useful when bending high tensile strength materials which have a great amount of spring back. The Multi-V is equipped with low friction, hardened roller bars which reduce marking on the outside of the part and also reduces the required bending force by 10% to 30% versus conventional bottom tools.

The Multi-V is manufactured in lengths ranging from 500 mm to 1050 mm and the Multi-V lengths can be combined to make any required length.

There are 4 standard Multi-V models available: Models B, D, E, and F ranging from a minimum opening of 24 mm to a maximum opening of 400 mm. See fig. 4.2 and the table. The Bottom Tool Holder (saddle) for the Multi-V is 40 mm thick as standard configuration and can be supplied as a flat bottom, with a tang or as a bolt-down.

Semi-automatic Multi-V versions are also available for the larger models E and F, whereby a chain drive mechanism is built into the bottom holders to open and close the Multi-V jaws via an electric drill, rather than manually.

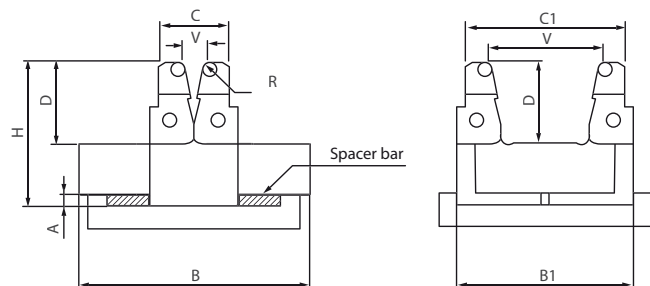

Fig. 4.2

MULTI-V

Model	V-opening	Max load at 90°	A	B	B1	C	C1	D	H	R
B	24-124 mm	125 t/m	15	254	197	77	177	90	160	8
D	65-180 mm	200 t/m	15	324	277	160	277	90	160	12.5
E	120-300 mm	400 t/m	20	510	447	267	447	130	250	20
F	150-400 mm	600 t/m	25	680	585	335	585	190	350	25



TOOLING

CUSTOM STYLE

TOOLING FLATTENING TOOLS (DD)

Flattening tools (often called Hemming or Dutch bending tools) are used to pre-bend the sheet and then press it closed (Fig. 4.3). This technique is used, for example, to finish the sharp edges of the ends of a sheet or to reinforce the sheet and thus strengthen the bent product.

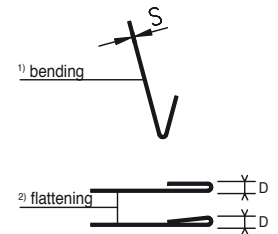

Fig. 4.3

Depending on the available tonnage and the sheet to be bent (material type and thickness), the sheet can be pressed closed to a greater or lesser extent. The force table on page 113 lists the tonnages required for closing the sheet for mild steel 42 kN/cm² and for stainless steel 70 kN/cm². The values as indicated may deviate slightly in actual practice.

A variety of tools in the WILA program can be used to perform this bending operation. If hemming is done only occasionally, a two step operation is often used with the first operation bending to 30° using standard 30° top and bottom tools. The second operation uses top and bottom flattening tools to close the hem (Fig 4.4). Because of the side forces that occur when flattening the sheet, we advise that these tools be used on sheets that are no more than 2 mm.

Using the New Standard top tool type BIU-051, for example, combined with bottom tool type OZU-083, a flattening combination can be created that can be used for both pre-bending and flattening (Fig. 4.5). An advantage is that this tool can also be used for universal bending. Because the design configuration is centric, no sliding mechanism is required. We advise a maximum sheet thickness of 1,5 mm. with this tool combination.

The spring-action flattening tool, consisting of a holder with a spring-action flattening part, is another option (Fig. 4.6). When combined with a 28° top tool, the sheet can be pre-bent and then hemmed. Because the V opening can be adjusted to suit the sheet thickness, short flange lengths can be bent. This combination however cannot be used for universal bending. The range of products includes a number of standard designs, type DDU (page 86), with different V-openings.

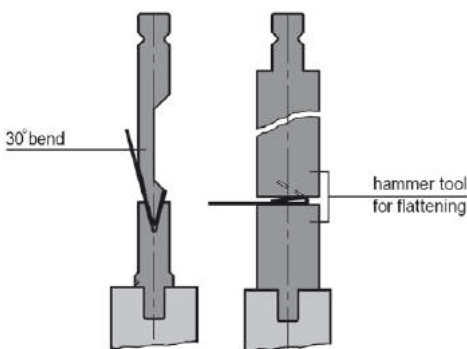

Fig. 4.4

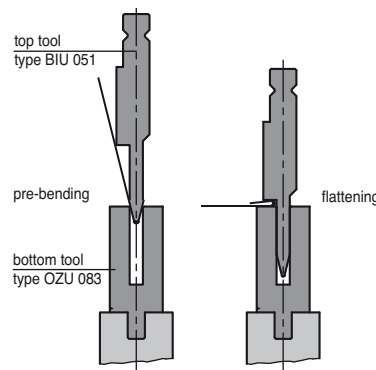

Fig. 4.5

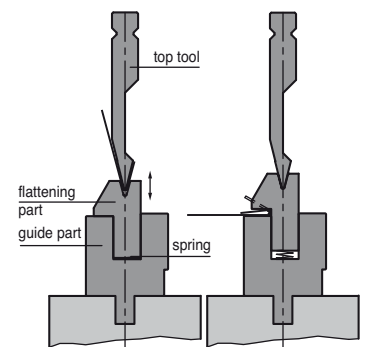

Fig. 4.6

As a modern version of the spring-action bending tool, WILA offers the hydraulic Dutch bending tool (Fig. 4.7). The pressing part is powered by hydraulic cylinders incorporated in the tool. When the tool is inactive, it is in a closed position, and simultaneously serves as a tool holder. Interchangeable bottom tools can be placed in the top of the flattening part, making it possible to adjust the size of the V-opening as desired. WILA offers a modified Hydraulic Power Pack (90 Bar max. pressure) for this purpose. Information available on request.

The spring-action and hydraulic flattening tools can be mounted on the machine in a number of ways:

- separately on the press brake's table.
- in the clamping slot in the table or lower beam using a tang on the bottom (Fig. 4.8).
- directly bolted on to the lower beam (Fig. 4.9), only hydraulic.

The hole pattern is available upon request. Here too, the hole pattern can be modified to suit the customer's needs. Both models can be standardly equipped with additional M16 holes 200 mm center to center, so that support arms and such can be attached.

The bottom tools used with the hydraulic flattening tool can be clamped in the tool in one of two ways:

- mechanically, using standard clamping bolts. These bolts are located in the middle of 1000 mm at 25 mm intervals, and in intervals of 100 mm towards each end.
- hydraulically, using built in Clamping-Pins.

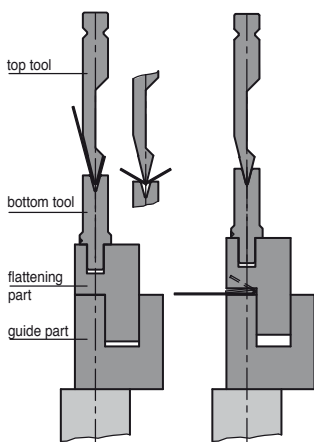

Fig. 4.7

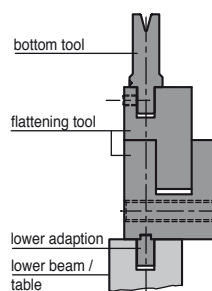

Fig. 4.8

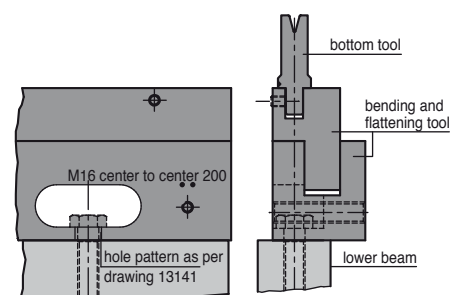
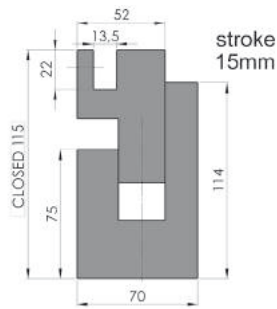

Fig. 4.9

DD-005 BENDING AND FLATTENING TOOL



Delivery	Standard	Optional
Manual Clamping	●	
Hydraulic lifting	●	
Hydraulic Power Pack		○
Mounting via bottom tang		○
Mounting via bolts directly to lower beam		○
<i>Usable for:</i>		
New Standard bottom tools	●	
American Style bottom tools	●	
Mild steel 0,5-2,0 mm	●	
Aluminum 0,5-2,5 mm	●	

Max. load 100 t/m | Weight 62 kg/m

DD-005 HI BENDING AND FLATTENING TOOL

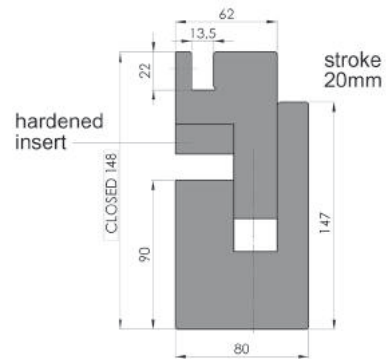

Delivery	Standard	Optional
Manual Clamping	●	
Hydraulic lifting	●	
Hydraulic Power Pack		○
Mounting via bottom tang		○
Mounting via bolts directly to lower beam		○
Hardened flattening inserts	●	
<i>Usable for:</i>		
New Standard bottom tools	●	
American Style bottom tools	●	
Mild steel 0,5-3,0 mm	●	
Aluminum 0,5-2,5 mm	●	
Stainless St. 0,5-2,0 mm	●	

Max. load 100 t/m | Weight 92 kg/m

DD-009 BENDING AND FLATTENING TOOL

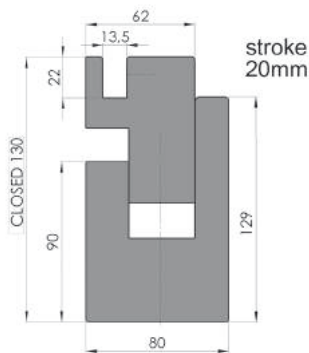

Delivery	Standard	Optional
Hydraulic Clamping	●	
Hydraulic lifting	●	
Hydraulic Power Pack		○
Mounting via bottom tang		○
Mounting via bolts directly to lower beam		○
<i>Usable for:</i>		
New Standard bottom tools	●	
American Style bottom tools	●	
Mild steel 0,5-3,0 mm	●	
Aluminum 0,5-3,0 mm	●	

Max. load 100 t/m | Weight 81 kg/m

DD-009 HI BENDING AND FLATTENING TOOL

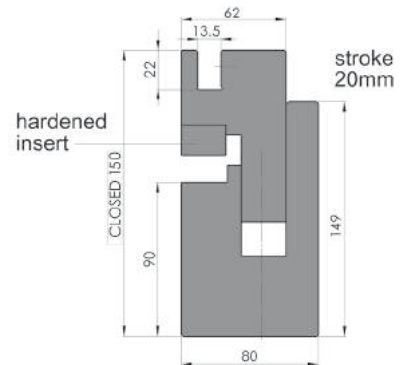

Delivery	Standard	Optional
Hydraulic Clamping	●	
Hydraulic lifting	●	
Hydraulic Power Pack		○
Mounting via bottom tang		○
Mounting via bolts directly to lower beam		○
Hardened Flattening Insert	●	
<i>Usable for:</i>		
New Standard bottom tools	●	
American Style bottom tools	●	
Mild steel 0,5-3,0 mm	●	
Aluminum 0,5-3,0 mm	●	
Stainless St. 0,5-2,0 mm	●	

Max. load 100 t/m | Weight 94 kg/m



BIU-051

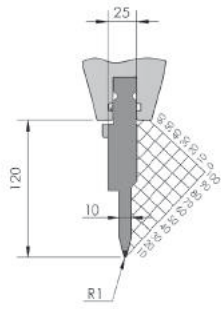

$\alpha=28^\circ$



BIU-053

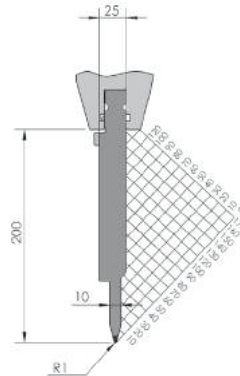

$\alpha=28^\circ$



Type	Length	Weight kg	Max load
BIU-051/1	515 mm	11,3	100 t/m
BIU-051/2 ¹	550 mm - sectioned	12,1	
BIU-051/3 ¹	200 mm - sectioned	4,4	
BIU-051/6 ³	200 mm	4,4	
BIU-051/11	200 mm - sectioned, horns	3,4	
BIU-051/12	255 mm	5,4	

Type	Length	Weight kg	Max load
BIU-053/1 ²	515 mm	19,5	100 t/m
BIU-E2M-053/1	515 mm	19,5	
BIU-053/2 ¹	550 mm - sectioned	20,8	
BIU-053/3 ¹	200 mm - sectioned	7,6	
BIU-053/6 ³	200 mm	7,6	
BIU-053/11	200 mm - sectioned, horns	5,8	
BIU-053/12	255 mm	9,5	

OZU-083

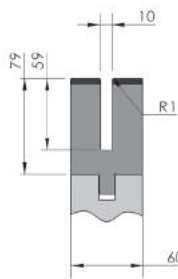

V=10 mm



OZU-381

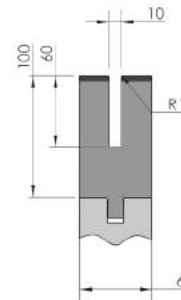

V=10 mm



Type	Length	Weight kg	Max load	
			Bending	Flattening
OZU-083/1	515 mm	18,0	50 t/m	100 t/m
OZU-083/6 ³	200 mm	7,0		
OZU-083/12	255 mm	9,2		

Type	Length	Weight kg	Max load	
			Bending	Flattening
OZU-381/1	515 mm	23,0	50 t/m	100 t/m
OZU-E2M-381/1	515 mm	23,0		
OZU-381/6 ³	200 mm	8,9		
OZU-381/12	255 mm	11,1		

¹ Individual tool sections also available. ² Provided with fixed Safety-Pins (see page 42). ³ /6 will be phased out

ADAPTION



NS I head load

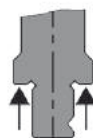

NS VI shoulder load with V-Lock®

SELF-LOCKING



Tools are clamped using a pneumatically-controlled pair of self-adjusting wedges. When the wedges are engaged (clamped), they become an integral part of the tool.

The Self-Locking® principle is suitable for clamping WILA's New Standard top and bottom tools (BIU and OZU). The Premium clamping is also released pneumatically.

BIU-061

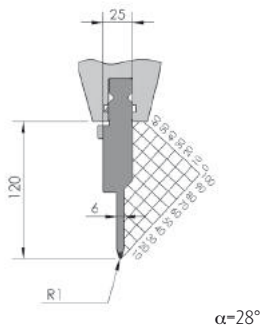

BIU-063

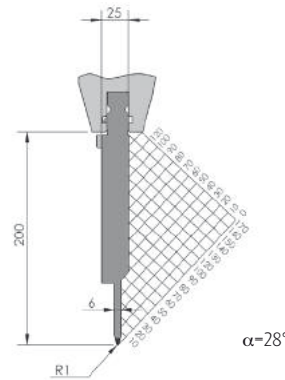

Type	Length	Weight kg	Max load
BIU-061/1	515 mm	10,4	50 t/m
BIU-061/2 ¹	550 mm - sectioned	11,1	
BIU-061/3 ¹	200 mm - sectioned	4,0	
BIU-061/6 ³	200 mm	4,0	
BIU-061/11	200 mm - sectioned, horns	3,2	
BIU-061/12	255 mm	5,0	

Type	Length	Weight kg	Max load
BIU-063/1 ²	515 mm	19,5	50 t/m
BIU-E2M-063/1	515 mm	19,5	
BIU-063/2 ¹	550 mm - sectioned	20,8	
BIU-063/3 ¹	200 mm - sectioned	7,6	
BIU-063/6 ³	200 mm	7,6	
BIU-063/11	200 mm - sectioned, horns	5,6	
BIU-063/12	255 mm	9,1	

OZU-082

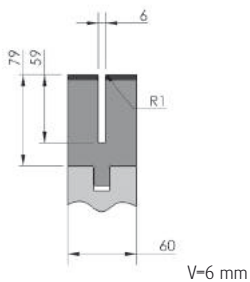

OZU-382

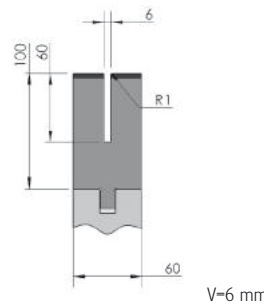

Type	Length	Weight kg	Max load	
			Bending	Flattening
OZU-082/1	515 mm	18,5	50 t/m	100 t/m
OZU-082/6 ³	200 mm	7,2		
OZU-082/12	255 mm	9,2		

Type	Length	Weight kg	Max load	
			Bending	Flattening
OZU-382/1	515 mm	23,2	50 t/m	100 t/m
OZU-E2M-382/1	515 mm	23,2		
OZU-382/6 ³	200 mm	9,0		
OZU-382/12	255 mm	11,1		

¹ Individual tool sections also available. ² Provided with fixed Safety-Pins (see page 42). ³ /6 will be phased out.

SEGMENTED TOOLING PROVIDES COMPLETE FLEXIBILITY

Create any desired tooling length from 20 mm to machine length in 5 mm increments by combining tool segments.

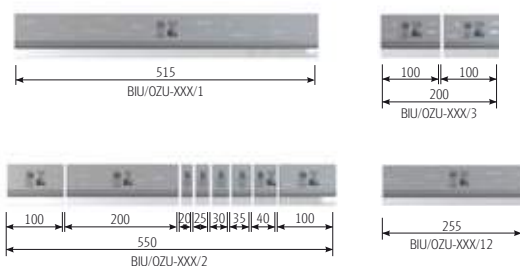

Examples of tool segments combined for various machine lengths			
550 mm segmented set	255 mm	515 mm	Total length
1	1	1	1320 mm
1	1	2	1835 mm
1	2	3	2605 mm
1		5	3125 mm
1		6	3640 mm
1	1	7	4410 mm

DDU-001

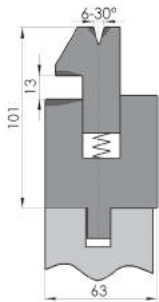

Type	Length	Weight kg	Max load	
			Bending	Flattening
DDU-001/1	515 mm	20,0	60 t/m	100 t/m

Bending and flattening tool, provided with V=6 mm - 30°. Max. sheet thickness 1 mm. Flattening part operated by spring action, stroke 13 mm. Closed working height 88 mm.

DDU-002

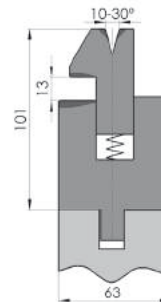

Type	Length	Weight kg	Max load	
			Bending	Flattening
DDU-002/1	515 mm	19,7	70 t/m	100 t/m

Bending and flattening tool, provided with V=10 mm - 30°. Max. sheet thickness 1,5 mm. Flattening part operated by spring action, stroke 13 mm. Closed working height 88 mm.

DDU-004

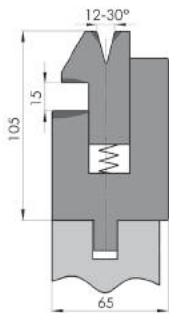

Type	Length	Weight kg	Max load	
			Bending	Flattening
DDU-004/1	515 mm	22,3	70 t/m	100 t/m

Bending and flattening tool, provided with V=12 mm - 30°. Max. sheet thickness 2 mm. Flattening part operated by spring action, stroke 15 mm. Closed working height 90 mm.

DDU-003

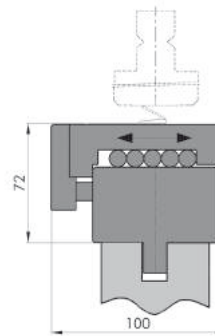

Type	Length	Weight kg	Max load

Moving flattening bottom tool with rollers for material thickness 2-4 mm. Suitable for use in combination with flattening top tool. Working height 72 mm.

ADAPTION



NS I head load

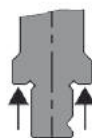

NS VI shoulder load with V-Lock®

WEBSHOP



The WILA Webshop features a comprehensive overview of WILA's top and bottom tools. The Webshop can be used to request quotes, check prices, find delivery times, and place orders directly or through your preferred ASP. Create your account via: www.wilatooling.com

BIU-041

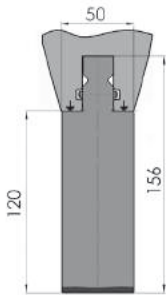

OZU-384

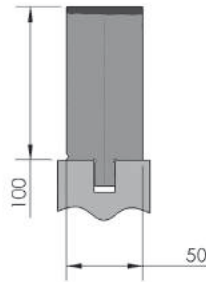

Type	Length	Weight kg	Max load
BIU-041/1 ²	515 mm	27,7	100 t/m
BIU-E2M-041/1	515 mm	27,7	

Flattening tool to be used in combination with bottom tools DDU-003 and OZU-384.
Max. sheet thickness 2 mm.

Type	Length	Weight kg	Max load
OZU-384/1	515 mm	21,5	100 t/m
OZU-E2M-384/1	515 mm	21,5	

Flattening tool to be used in combination with top tool BIU-041.
Max. sheet thickness 2 mm.

¹ Individual tool sections also available. ² Provided with fixed Safety-Pins (see page 42)

SEGMENTED TOOLING PROVIDES COMPLETE FLEXIBILITY

Create any desired tooling length from 20 mm to machine length in 5 mm increments by combining tool segments.

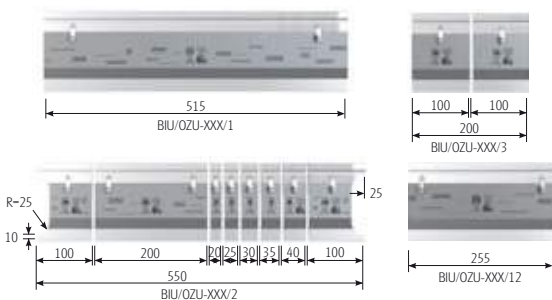

Examples of tool segments combined for various machine lengths			
550 mm segmented set	255 mm	515 mm	Total length
1	1	1	1320 mm
1	1	2	1835 mm
1	2	3	2605 mm
1		5	3125 mm
1		6	3640 mm
1	1	7	4410 mm

TOOL EXTENDERS/TOOLING

To complement its Clamping, Crowning, and Tooling lines, WILA offers an extensive extender program to provide additional versatility to the sheet metal fabricator. Be it Holders (HU) for radius, offset or non marking inserts or adapters (TSU) to be able to go between different tooling styles, or extenders for deep box bending, or bottom tool risers, WILA has the solution for you.

Also find additional information on the fact sheet on page 41.



HU-004



HU-024

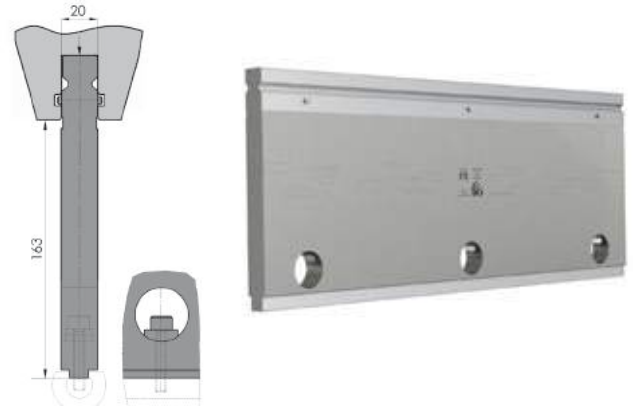

Type	Length	Weight kg	Max load
HU-004/1	515 mm	9,8	160 t/m
HU-E2M-004/1	515 mm	9,8	

Holder suitable for various radius and flattening tools. Top provided with New Standard adaption, with Safety-Pins. Working height dependent on the radius tools to be used.

Type	Length	Weight kg	Max load
HU-024/1	515 mm	15,1	160 t/m
HU-E2M-024/1	515 mm	15,1	

Holder suitable for various radius and flattening tools. Top provided with New Standard adaption, with Safety-Pins. Working height dependent on the radius tools to be used.

RU-001



RU-002

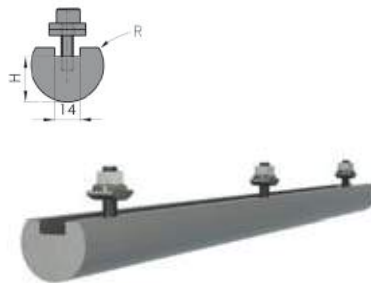

RU-003

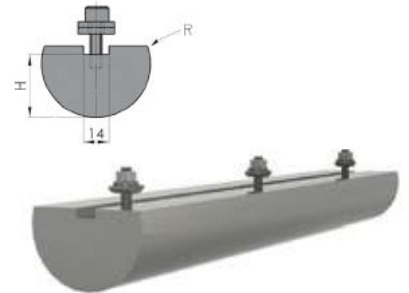

Type	Length mm	R mm	H mm	Weight kg	Max load
RU-001/R7/1	515	7	11,5	0,6	100 t/m
RU-001/R7.5/1	515	7,5	11,5	0,6	
RU-001/R8/1	515	8	13	0,7	
RU-001/R9/1	515	9	16	1,0	
RU-001/R10/1	515	10	16	1,2	
RU-002/R12.5/1	515	12,5	16	1,6	100 t/m
RU-002/R15/1	515	15	20	2,4	
RU-002/R17.5/1	515	17,5	22	3,2	
RU-002/R20/1	515	20	24	4,2	
RU-003/R25/1	515	25	29	6,1	100 t/m
RU-003/R30/1	515	30	34	8,3	
RU-003/R40/1	515	40	45	12,9	
RU-003/R50/1	515	50	54	21,3	

Radius tools Non-hardened.
Radius 7-50 mm to be used in combination with holder type HU-004-024 and 124.

TOOL EXTENDERS
TOOLING

NEW STANDARD PRO

HU-124

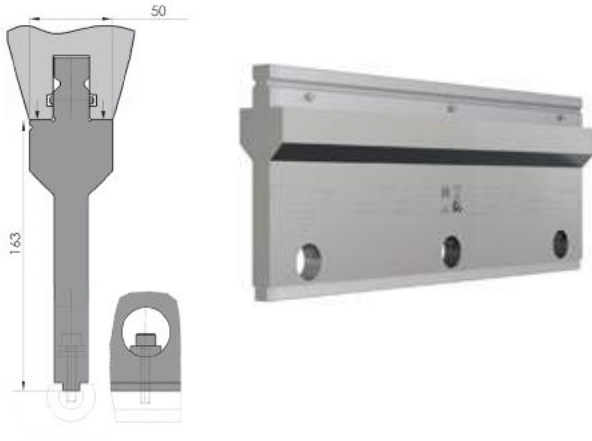

Type	Length	Weight kg	Max load
HU-124/1	515 mm	20,6	250 t/m
HU-E2M-124/1	515 mm	20,6	

Holder suitable for various radius and flattening tools. Top provided with New Standard adaption, with Safety-Pins. Working height dependent on the radius tools to be used.

RU-004



Type	Length	Weight kg	Max load
RU-004/1	515 mm	2,4	100 t/m

Flattening tool to be used in combination with holder types HU-004-024-124. Max. sheet thickness 2 mm. Non-hardened.

RU-104



Type	Length	Weight kg	Max load
RU-104/1	515 mm	2,4	100 t/m

Flattening tool to be used in combination with holder types HU-004-024-124. Max. sheet thickness 2 mm. CNC-Deeaphardened®.

RU-101



RU-102

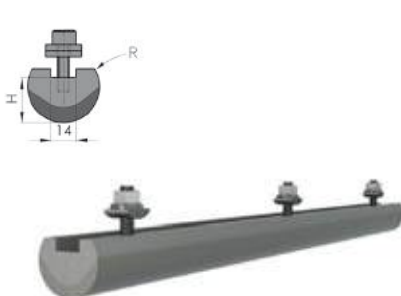

RU-103

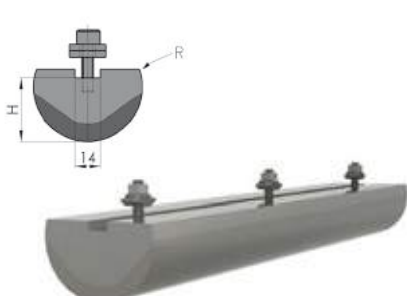

Type	Length mm	R mm	H mm	Weight kg	Max load
RU-101/R7/1	515	7	11,5	0,6	175 t/m
RU-101/R7.5/1	515	7,5	11,5	0,6	
RU-101/R8/1	515	8	13	0,7	
RU-101/R9/1	515	9	16	1,0	
RU-101/R10/1	515	10	16	1,2	
RU-102/R12.5/1	515	12,5	16	1,6	225 t/m
RU-102/R15/1	515	15	20	2,4	
RU-102/R17.5/1	515	17,5	22	3,2	
RU-102/R20/1	515	20	24	4,2	
RU-103/R25/1	515	25	29	6,1	250 t/m
RU-103/R30/1	515	30	34	8,3	
RU-103/R40/1	515	40	45	12,9	
RU-103/R50/1	515	50	54	21,3	

Radius tools. CNC-Deeaphardened®
Radius 7-50 mm to be used in combination with holder type HU-004-024 and 124.

HU-034

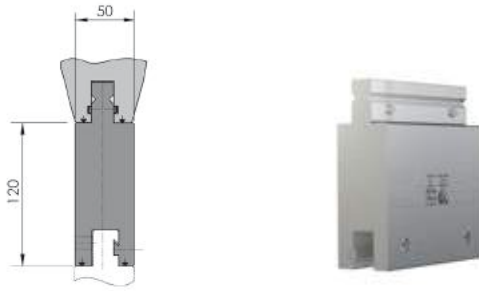

HU-134

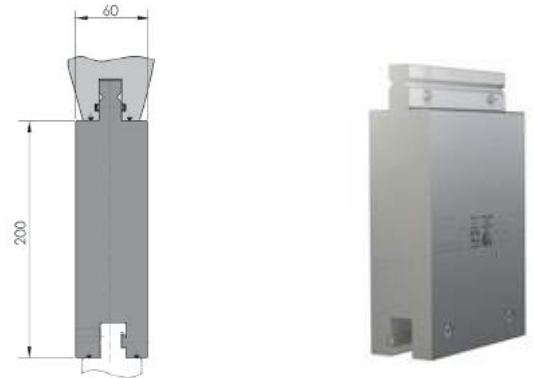

Type	Length	Weight kg	Max load
HU-034/1	515 mm	25,2	300 t/m
HU-E2M-034 /1	515 mm	25,2	

Holder for radius inserts RU-105 and RU-106 and RU with HU-107 adaption. Top with New Standard adaption with Safety-Pins or with E2M® adaption.

Type	Length	Weight kg	Max load
HU-134/1	515 mm	49,7	500 t/m
HU-E2M-134 /1	515 mm	49,7	

Holder for radius inserts RU-105 and RU-106 and RU with HU-107 adaption. Top with New Standard adaption with Safety-Pins or with E2M® adaption.

RU-105



$\alpha=60^\circ$

RU-106



$\alpha=60^\circ$

Type	Length	Weight kg	Max load
RU-105/1	515 mm	9,2	160 t/m

Slide-on radius insert. To be used in combination with holder HU-034 or HU-134.

Type	Length	Weight kg	Max load
RU-106/1	515 mm	10,2	255 t/m

Slide-on radius insert. To be used in combination with holder HU-034 or HU-134.

ADAPTION

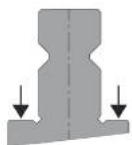

NS II shoulder load

E2M SAFETY ROLLER BEARING



New Standard E2M® top and bottom tools are equipped with special (pre-assembled) bearings, which allow you to move the tools laterally in a non-clamped state quickly and safely.

HU-107

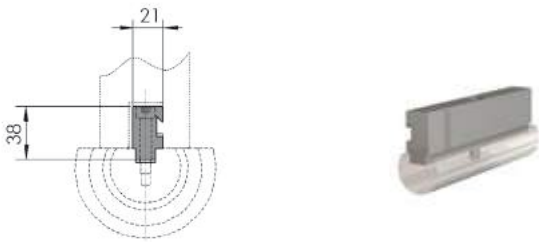

Type	Length	Weight kg	Max load
HU-107/1	515 mm	3,0	-

Adaption suitable for radius inserts RU-007 and RU-107 to use as slide-on radius in combination with HU-034 or HU-134.

RU-007

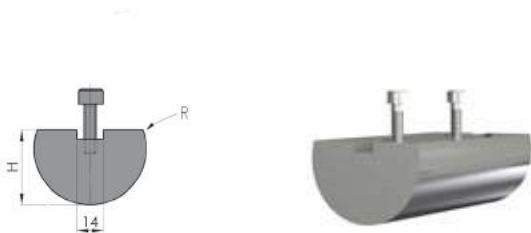

Type	Length mm	R mm	H mm	Weight kg	Max load
RU-007/R=25/1	515	25	39	6,1	200 t/m
RU-007/R=30/1	515	30	44	8,3	
RU-007/R=40/1	515	40	54	12,7	
RU-007/R=50/1	515	50	64	21,3	

Radius inserts, not hardened. Radius 25-50 mm to be used in combination with adaption type HU-107/1.

RU-107



Type	Length mm	R mm	H mm	Weight kg	Max load
RU-107/R=25/1	515	25	39	6,1	500 t/m
RU-107/R=30/1	515	30	44	8,3	
RU-107/R=40/1	515	40	54	12,7	
RU-107/R=50/1	515	50	64	21,3	

Radius inserts, CNC-Deephardened® Radius 25-50 mm to be used in combination with adaption type HU-107/1.

TOOL EXTENDERS
TOOLING

NEW STANDARD PRO

PRESS BRAKE PRODUCTIVITY WAX



Press Brake Productivity Wax is a spray that has been specially developed for cleaning, maintaining and protecting WILA tools.

TOOL HOLDERS



Holders suitable for use with various inserts for offset Z bends and for flattening, advantages:

- easy to use
- no more time-consuming tool alignment
- one Tool Holder can be used for multiple size inserts and applications

HU-001 Top Holder can be used in combination with either HU-005 or HU-006 Bottom Holder.

HU-001

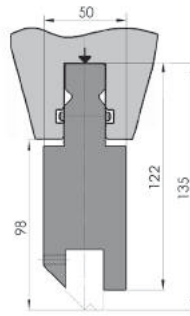

Type	Length	Weight kg	Max load
HU-001/1	515 mm	17,5	100 t/m

Top Holder, top provided with New Standard adaption and Safety-Pins.
Bottom suitable for inserts type INZU. Working height 98 mm incl. inserts.

HU-005



Type	Length	Weight kg	Max load
HU-005/1	515 mm	13,4	100 t/m

Bottom Holder, bottom provided with the OZU adaption, 13x20 mm (WxH).
Top suitable for inserts type INZU. Working height 74 mm incl. inserts.

HU-006

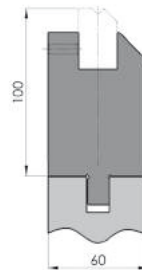

Type	Length	Weight kg	Max load
HU-006/1	515 mm	19,3	100 t/m

Bottom Holder, bottom provided with the OZU adaption, 13x20 mm (WxH).
Top suitable for inserts type INZU. Working height 100 mm incl. inserts.

TOOL EXTENDERS TOOLING NEW STANDARD PRO

ADAPTION



NS I head load

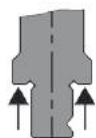

NS VI shoulder load with V-Lock®

INSERT FOR OFFSET BENDING



In addition to the range of top and bottom tools, WILA also offers a wide range of accessories. These include special inserts for making offset (Z bends, INZU-001 and INZU-002) or to flatten material (INZU-003). The INZU program also includes special plastic inserts for mark-free bending of sensitive materials (INZU-005 to INZU-007). These inserts can be used with holders type HU.

INZU-001

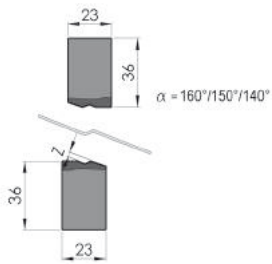

Z = 1 and 1.5	160°
Z = 2	150°
Z = 3	140°

INZU-002

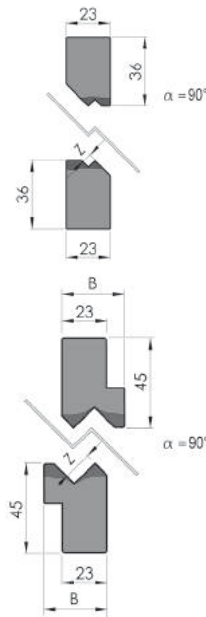

INZU-003

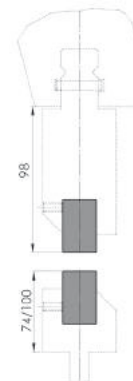
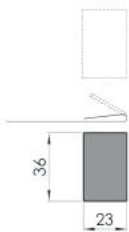

Type	Length mm	B	Z mm	Weight kg	Max load	
INZU-001/Z1/1	515		1,0	6,7	100 t/m	Set of inserts, top and bottom, for making offsets. Suitable for use in combination with holders HU-001, 005 and 006.
INZU-001/Z1,5/1	515		1,5	6,7		
INZU-001/Z2/1	515		2,0	6,6		
INZU-001/Z2,5/1	515		2,5	6,6		
INZU-002/Z3/1	515		3,0	6,3	100 t/m (α-90°)	Set of inserts, top and bottom, for making offsets. Suitable for use in combination with holders HU-001, 005 and 006.
INZU-002/Z3,5/1	515		3,5	6,3		
INZU-002/Z4/1	515		4,0	6,3		
INZU-002/Z4,5/1	515		4,5	6,3		
INZU-002/Z5/1	515		5,0	6,3		
INZU-002/Z5,5/1	515		5,5	6,3		
INZU-002/Z6/1	515		6,0	6,3		
INZU-002/Z6,5/1	515		6,5	6,3		
INZU-002/Z7/1	515		7,0	6,3		
INZU-002/Z7,5/1	515		7,5	6,3		
INZU-002/Z8/1	515		8,0	6,2		
INZU-002/Z10/1	515	27	10,0	8,5		
INZU-002/Z13/1	515	32	13,0	8,3		
INZU-002/Z15/1	515	32	15,0	8,3		
INZU-003/1	515		-	6,8	100 t/m	Insert to flatten or complete them. For top and bottom flattening insert, order two INZU-003/1. Max sheet thickness 2 mm. Suitable for use in combination with holders HU-001, 005 and 006.

INZU-005



INZU-006



Type	Length	Weight kg	Max load
INZU-005/1	515 mm	0,5	20 t/m

Synthetic inserts for bending material without marking. To be used in bottom holders type HU-005 and HU-006, see page 94. Use dependent on material type, thickness, angles and radius size.

Type	Length	Weight kg	Max load
INZU-006/1	515 mm	0,5	20 t/m

Synthetic inserts for bending material without marking. To be used in bottom holders type HU-005 and HU-006, see page 94. Use dependent on material type, thickness, angles and radius size.

INZU-007

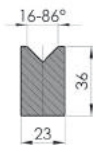

Type	Length	Weight kg	Max load
INZU-007/1	515 mm	0,5	20 t/m

Synthetic inserts for bending material without marking. To be used in bottom holders type HU-005 and HU-006, see page 94. Use dependent on material type, thickness, angles and radius size.

K-001/5

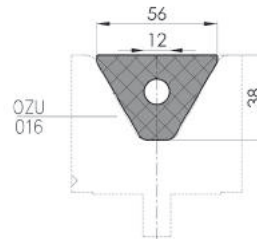

Type	Length	Weight kg	Max load
K-001/5	ca 2100 mm	1,5	-

Adiprene inserts for bending material without marking. To be used in bottom tools type OZU-016 and OZU-327. Use dependent on material type, thickness, angles and radius size. Available in 85 Shore A and 95 Shore A.

TOOL ADVISOR



This high-end engineering tool allows you to make a decision online about which press brake tools are best suited to your specific bending needs. If the required tool is unavailable as a standard solution, it is possible to immediately design a special tool and order it via the WILA Webshop.

TSU-020

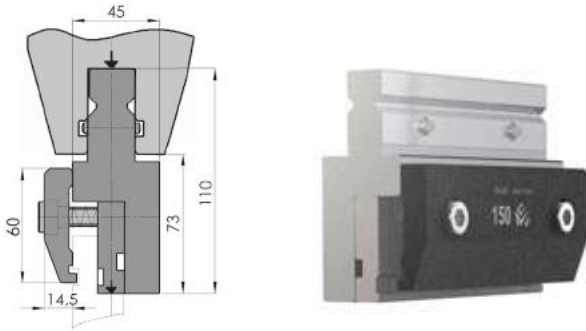

Type	Length	Weight kg	Max load
TSU-020/1	515 mm	16,2	100 t/m
TSU-E2M-020/1	515 mm	16,2	
TSU-020/4	150 mm	4,8	

Adapter, New Standard to European or American. Top provided with New Standard adaption and Safety-Pins. Bottom side interchangeable between European Style I and American Style adaptation and with clamping plate type TK-031.

TSU-021

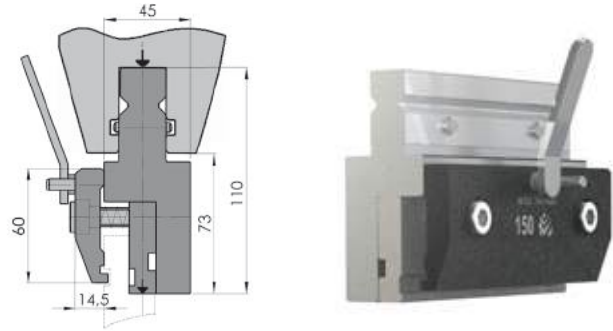

Type	Length	Weight kg	Max load
TSU-021/1	515 mm	16,2	100 t/m
TSU-E2M-021/1	515 mm	16,2	
TSU-021/4	150 mm	4,8	

Adapter, New Standard to European or American. Top provided with New Standard adaption and Safety-Pins. Bottom side interchangeable between European Style I and American Style adaptation and with clamping plate type TK-032.

TSU-022

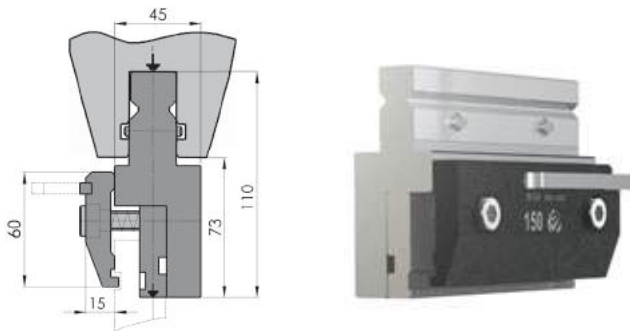

Type	Length	Weight kg	Max load
TSU-022/1	515 mm	16,2	100 t/m
TSU-E2M-022/1	515 mm	16,2	
TSU-022/4	150 mm	4,8	

Adapter, New Standard to European or American. Top provided with New Standard adaption and Safety-Pins. Bottom side interchangeable between European Style I and American Style adaptation and with clamping plate type TK-033.

TK-031

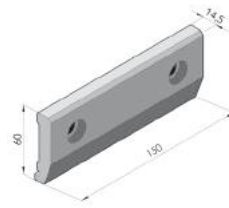

TK-032

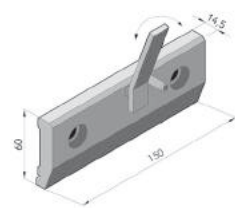

TK-033

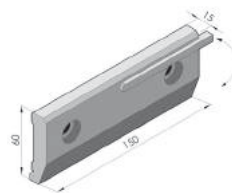

Example, if adapted to American Style adaption.

ADAPTION



NS I head load

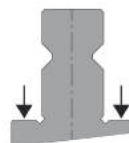

NS II shoulder load

SAFETY-PIN

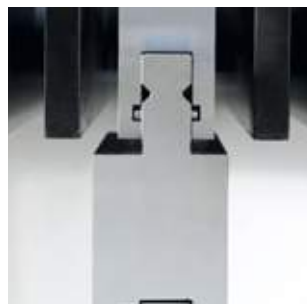

Tooling with a New Standard adaption and with sections weighing between 12,5-25 kg are equipped with fixed Safety-Pins, allowing for horizontal interchange only.

TSU-029

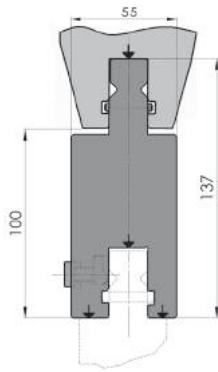

TSU-030

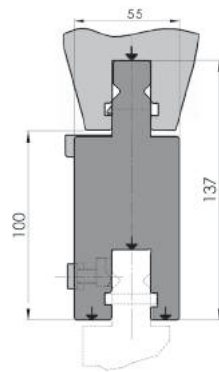

Type	Length	Weight kg	Max load
TSU-029/1	515 mm	22,2	100 t/m
TSU-E2M-029/1	515 mm	22,2	
TSU-029/4	150 mm	6,6	

Extender, top and bottom provided with New Standard adaption.
Top side, adaption provided with Safety-Pins. Bottom side with self-seating clamping bar.

Type	Length	Weight kg	Max load
TSU-030/4	150 mm	6,6	100 t/m

Extender, top and bottom provided with New Standard adaption.
Top side, adaption provided with Safety-Click®. Bottom side with self-seating clamping bar.

TSU-031

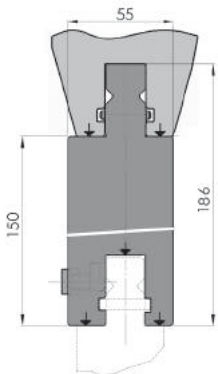

TSU-032

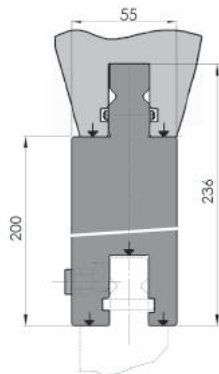

Type	Length	Weight kg	Max load
TSU-031/4	150 mm	9,9	180 t/m

Extender, top and bottom provided with New Standard adaption.
Top side, adaption provided with Safety-Pins. Bottom side with self-seating clamping bar.
Made-to-order. Other heights available on request.

Type	Length	Weight kg	Max load
TSU-032/4	150 mm	13,2	180 t/m

Extender, top and bottom provided with New Standard adaption.
Top side, adaption provided with Safety-Pins. Bottom side with self-seating clamping bar.
Made-to-order. Other heights available on request.

ADAPTION



NS I head load

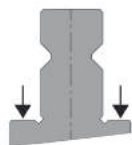

NS II shoulder load

EXTENDERS



Extenders are used between the press brake's upper Clamping (or Tool Holder) and the top tool. Often they are used to heighten the top configuration, making it possible to bend deep boxes. These extenders are supplied as modules in lengths of 150 mm and 515 mm. They are produced with extremely high precision, guaranteeing their interchangeability.

TSU-123

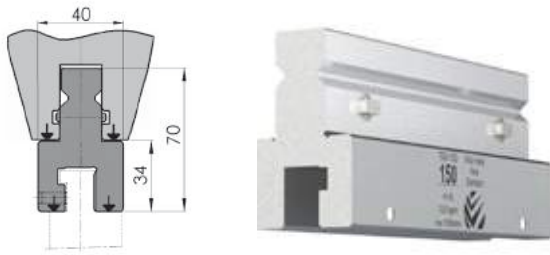

Typ	Length	Weight kg	Max load
TSU-123/1	515 mm	7,0	160 t/m
TSU-123/4	150 mm	2,0	

Adapter, New Standard to American Style. Top provided with New Standard adaption and Safety-Pins. Bottom provided with American Style I adaptation and 1 clamping screw every 100 mm.

TSU-024

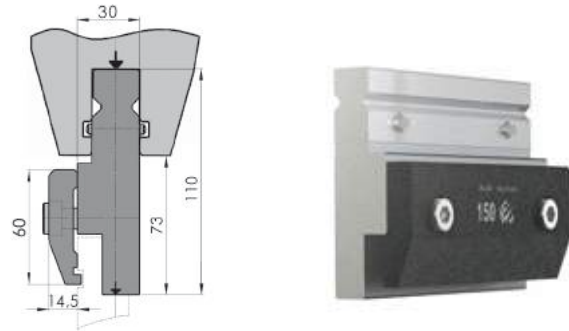

Type	Length	Weight kg	Max load
TSU-024/1	515 mm	12,9	100 t/m
TSU-E2M-024/1	515 mm	12,9	
TSU-024/4	150 mm	3,9	

Adapter, New Standard to European Style. Top provided with New Standard adaption and Safety-Pins. Bottom provided with European Style I adaptation and with clamping plate type TK-031.

TSU-025

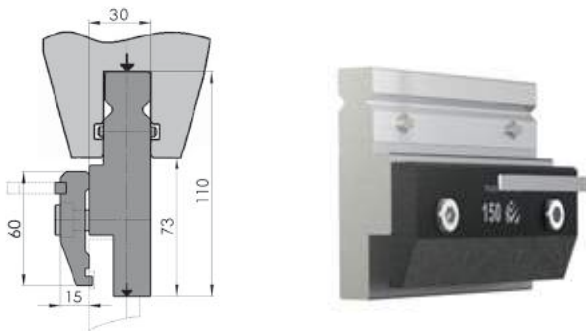

Type	Length	Weight kg	Max load
TSU-025/1	515 mm	12,9	100 t/m
TSU-E2M-025/1	515 mm	12,9	
TSU-025/4	150 mm	6,6	

Adapter, New Standard to European Style. Top provided with New Standard adaption and Safety-Pins. Bottom provided with European Style I adaptation and with clamping plate type TK-033.

TSU-026

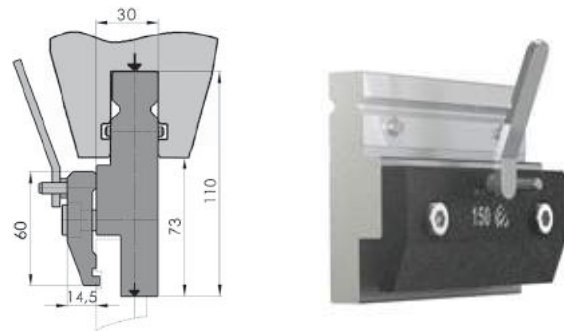

Type	Length	Weight kg	Max load
TSU-026/1	515 mm	12,9	100 t/m
TSU-E2M-026/1	515 mm	12,9	
TSU-026/4	150 mm	3,9	

Adapter, New Standard to European Style. Top provided with New Standard adaption and Safety-Pins. Bottom provided with European Style I adaptation and with clamping plate type TK-032.

ADAPTION



NS I head load

ADAPTERS



Adapters are used between the press brake's Clamping (or Tool Holder) and the top tool. Often they are used as an accessory to make the transition from one tool system to another. These adapters are supplied as modules in lengths of 150 and 515 mm. They are produced with extremely high precision, guaranteeing their interchangeability.

TSU-027

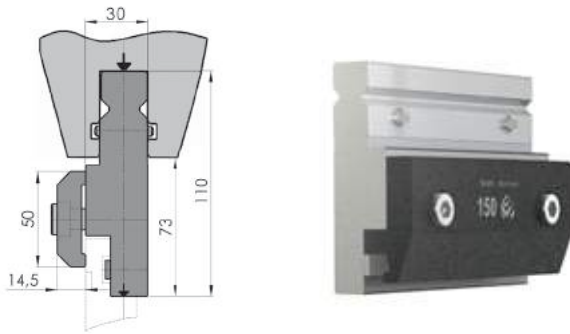

Type	Length	Weight kg	Max load
TSU-027/1	515 mm	12,6	100 t/m
TSU-E2M-027/1	515 mm	12,6	
TSU-027/4	150 mm	4,8	

Adapter, top provided with New Standard adaption and Safety-Pins. Bottom provided with European Style I adaptation with extra safety-slot, and with clamping plate type TK-034.

TSU-028

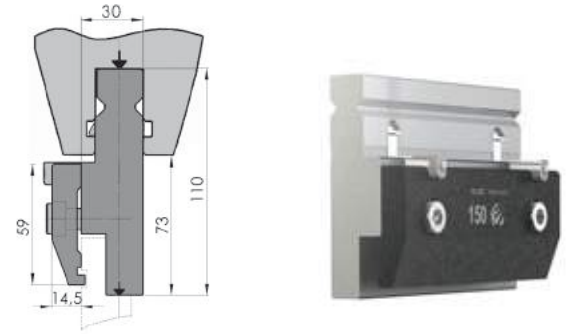

Type	Length	Weight kg	Max load
TSU-028/4	150 mm	6,6	100 t/m

Adapter, New Standard to European Style. Top provided with New Standard adaption and Safety-Clicks®. Bottom provided European Style I adaptation and with clamping plate type TK-035

TSU-033

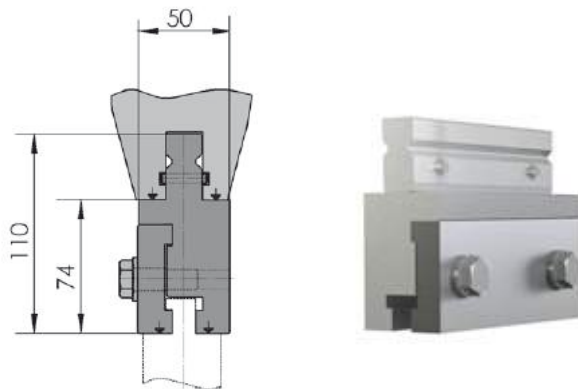

Type	Length	Weight kg	Max load
TSU-033/1	515 mm	17,3	250 t/m
TSU-E2M-033/1	515 mm	17,3	

Adapter New Standard to American Style. Top provided with New Standard adaption and Safety-Pins. Bottom side with clamping plate.

OBU-107

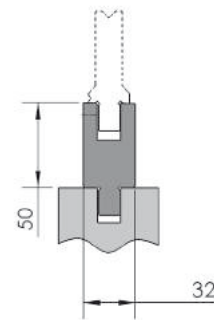

Type	Length	Weight kg	Max load
OBU-107/1	515 mm	6	180 t/m

Tool Holders/Extenders to increase height of existing OZU bottom tools.

ADAPTION



E2M® SAFETY ROLLER BEARING: TOP



E2M® top tools are provided with bearing safety pins in the adaption of the tool. Applicable for: head and shoulder load top tools with a minimum tool length of 100mm. Tool weight should be between 12.5kg and 100kg.

TOOL EXTENDERS TOOLING NEW STANDARD PRO

TS 802

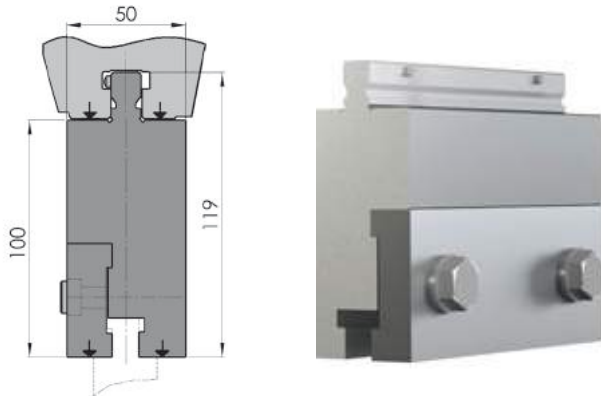

Type	Length	Weight kg/m	Max load
TS-802	Machine length	39,8	100 t/m

Extender, American Style to American Style. Top provided with American Style II adaption and Safety-Pins. Bottom with American Style I adaptation and clamping plate.
Made to order.

TS 804

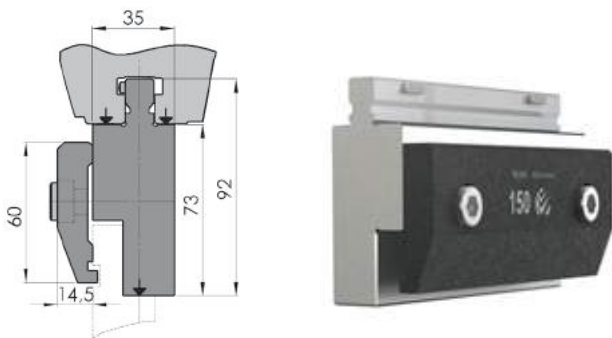

Type	Length	Weight kg/m	Max load
TS-804	Machine length	29,7	100 t/m

Adapter, American Style to European Style. Top provided with American Style II adaption and Safety-Pins. Bottom provided with European Style I adaptation and clamping plate TK-031. Made to order.

ADAPTION

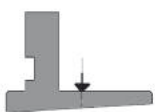

ES I shoulder load

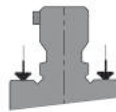

AS II shoulder load

TOOL ADVISOR



This high-end engineering tool allows you to make a decision online about which press brake tools are best suited to your specific bending needs. If the required tool is unavailable as a standard solution, it is possible to immediately design a special tool and order it via the WILA Webshop.

COMPONENTS

Comprehensive range of accessories

Our extensive assortment of accessories for press brakes and tools helps to maximize flexibility and extend their capabilities. WILA accessories are compatible with our New Standard Tooling and New Standard Tool Holders. From non-marking protective cloth to efficient Tool Storage Systems WILA has everything you need.



Hydraulic Power Pack HM10 and HM11 type H-R (with remote control).



Hydraulic Power Pack HM10 and HM11 type H (Manual operation) or C (linked to the CNC control).

HYDRAULIC POWER PACK

FOR USE IN COMBINATION WITH CLAMPING, CROWNING, BOTTOM TOOL HOLDERS & (A3) CLAMPING BARS.

Type	Features
HM10-400-H	Manual operation ¹ , 400V-50Hz-3ph
HM10-400-H-R	Manual operation ² , 400V-50Hz-3ph
HM10-400-C	Linked to the CNC control, 400V-50Hz-3ph
HM11-460/230-H dual voltage	Manual operation ¹ , 230/460V-60Hz-3ph, supplied at 460V
HM11-460/230-H-R dual voltage	Manual operation ² , 230/460V-60Hz-3ph, supplied at 460V
HM11-230/460-H dual voltage	Manual operation ¹ , 230/460V-60Hz-3ph, supplied at 230V
HM11-230/460-H-R dual voltage	Manual operation ² , 230/460V-60Hz-3ph, supplied at 230V
HM12-460/230 dual voltage	Fully integratable in the press brake ³ , valve 24 V supplied at 460V
HM13-400	Fully integratable in the press brake ³ , valve 24 V
Extra hydraulic hose	Hose L=2,5 m equipped with straight fitting and fitting for extra hose

Comments.

¹) Operation via push button on the Power Pack.

²) Comes with a remote control.

³) Only for press brake manufacturers

- All Hydraulic Power Packs have a Ø10 connection and are supplied with one hose measuring 2,5 meters.

- All Hydraulic Power Packs with dual voltage have been specially developed for the North American market.

PRESS BRAKE PRODUCTIVITY CABINETS®

In order to be able to store tools in an organized and safe way, WILA has put on the market its Press Brake Productivity Cabinet.



COMPONENTS

DRAWER SAFETY LOCK



All drawers are provided with an additional locking device to ensure that the drawer never can be opened by itself.

These tool cabinets are delivered standard with:

- 1 shallow drawer, weight capacity of 100 kg, to store measuring tools etc.
 - A base with removable kick plates front and back to allow for easy movement with fork-lift or pallet truck.
 - A tilting guard, so that only 1 drawer at a time can be opened.
 - Lockable doors.
 - All drawers are provided with an additional locking device.
 - A black rubber mat on top.
 - 5 drawers with perforated bottom, weight capacity of 200 kg each. The distance between the drawers can be adjusted easily in steps of about 25 mm.
 - The arrangement of the tool drawers can be adjusted according to the height of the tools to be stored.
 - Each drawer has two bottom plates made from practically indestructible nylon with milled slots designed especially to hold vertically all WILA tools according to their adaption widths.
- Each drawer also includes one nylon spacer plate.

- WILA has 3 bottom plates in the program.
 - Bottom plate type no. 377487 suitable for the OZU lower tools of the complete New Standard program, and the BIU top tools of the American Style and American Vintage programs with AS II adaption.
 - Bottom plate type no. 22086 suitable for the BIU top tools of the complete New Standard program.
 - Bottom plate type 22084 suitable for American Style top tools with AS I adaption.
 - Drawers, bottom and spacer plates (type no. 22088) can be delivered separately.

WILA has more cabinet arrangements available, more information can be received upon request.

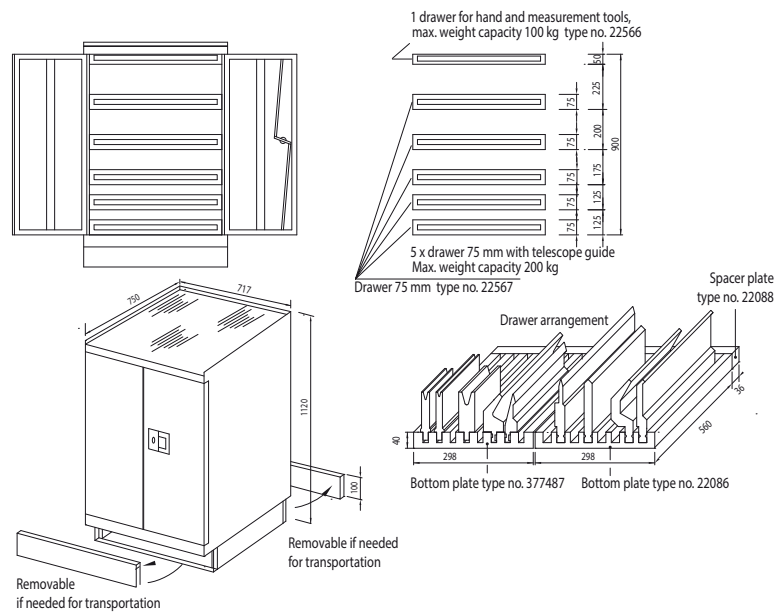

USABLE FOR TOOLS WITH ADAPTION



NS I head load

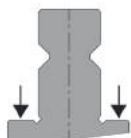

NS II shoulder load

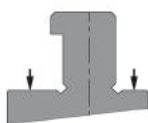

AS I shoulder load

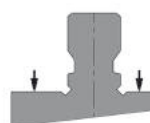

AS II shoulder load

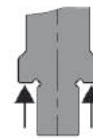

NS V shoulder load



NS VI shoulder load with V-Lock®

AUTOMATIC TOOL CHANGE (ATC) GRIPPER

With the WILA Gripper, it is possible for robotic press brakes to bend small batches of various products in random order fully automatically. Now bending on demand has been made possible.

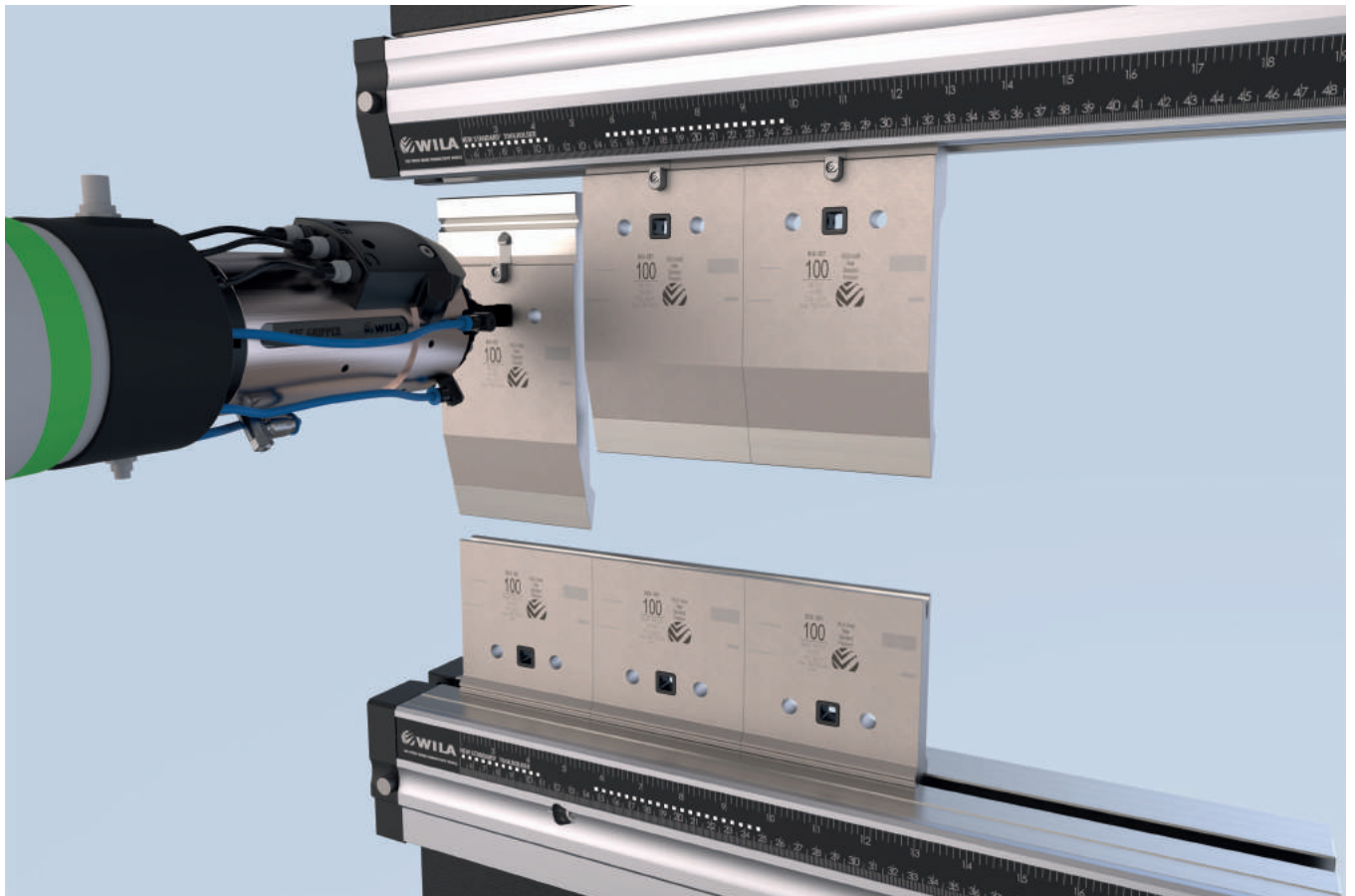

With automatic tool changes, the tool set-ups in your press brake are no longer the limiting factor in the variety of parts that can be formed entirely unmanned. The robot can change the part manipulator to the ATC Gripper, to be able to change tools quickly and efficient. The ATC Gripper can only handle special WILA ATC tooling (optionally executed with a TIPS ID-tag).

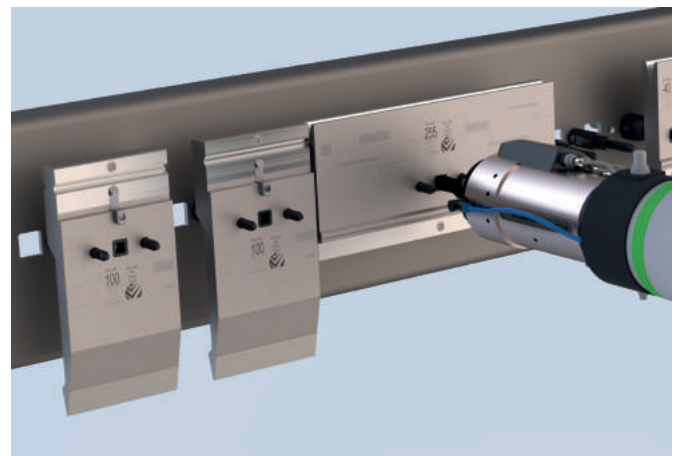

ATC GRIPPER

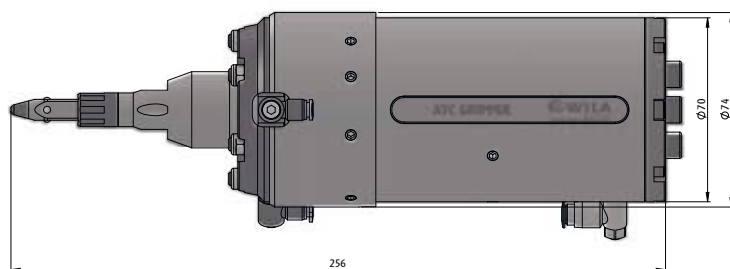

Allow automatic loading and unloading of all current models of our New Standard tooling program executed with ATC Adaptor

DOCKING STATION

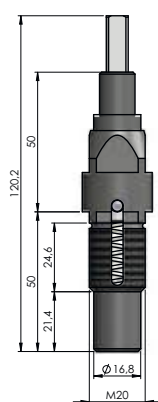

Holds current models of our New Standard tooling program executed with ATC Adaptor up to 100 mm.

SET DOCKING PINS

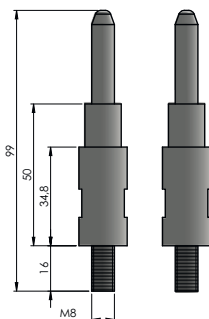

Set of 2 Docking Pins. Holds current models of our New Standard tooling program executed with ATC Adaptor \geq 100 mm.

ATC-ADAPTOR BIU



New Standard top tools (BIU) with lengths from 20-255 mm, when equipped with this ATC-Adaptor, can be automatically loaded and unloaded by the ATC Gripper. In this case the ATC Gripper will operate the Safety-Click! Max tool weight is 12,5 kg. Adaptor can be placed in new and existing BIU top tools.

ATC-ADAPTOR OZU



New Standard bottom tools (OZU) with lengths from 20-255 mm, when equipped with this ATC-Adaptor, can be automatically loaded and unloaded by the ATC gripper. Max tool weight is 12,5 kg. Adaptor can be placed in new and existing OZU bottom tools.

ATC GRIPPER

Specifications	
Size	Ø74 *256 mm
Weight	2,6 kg
Max. tool weight	12,5 kg
Min. ~ max. tool length	20 ~ 255 mm
Tool shapes	handles the WILA New Standard ATC top and bottom tools

K-001/5

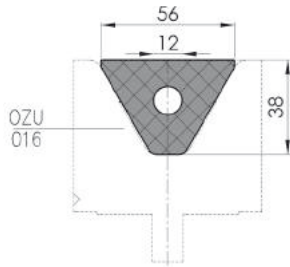

Type	Length	Weight kg	Max load
K-001/5	ca 2100 mm	1,5	-

Adiprene inserts for bending material without marking. To be used in bottom tools type OZU-016. Use dependent on material type, thickness, angles and radius size. Available in 85 Shore A and 95 Shore A.

K-003

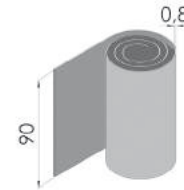

Type	Length	Weight kg	Max load
K-003	unlimited	-	-

Protective foil for bending material without marking. Use dependent on material type, thickness, angles, radius size and bending method.

K-004

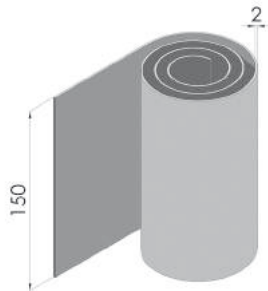

Type	Length	Weight kg	Max load
K-004	unlimited	-	-

Protective foil for bending material without marking. Use dependent on material type, thickness, angles, radius size and bending method.

K-005

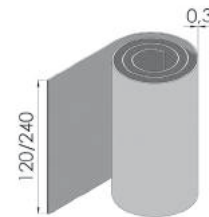

Type	Length	Weight kg	Max load
K-005/120	unlimited	-	-
K-005/240	unlimited	-	-

Protective Cloth for bending material without marking. Use dependent on material type, thickness, angles, radius size and bending method.

USE OF FOIL OR CLOTH TO AVOID MARKING

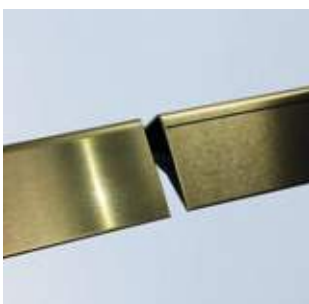

Foil or cloth can help to avoid marking on your part.

Advantage:

- No scratches, therefore no post-processing necessary.
- Time and cost savings.

CLAMPING SYSTEM FOR K-003/4/5

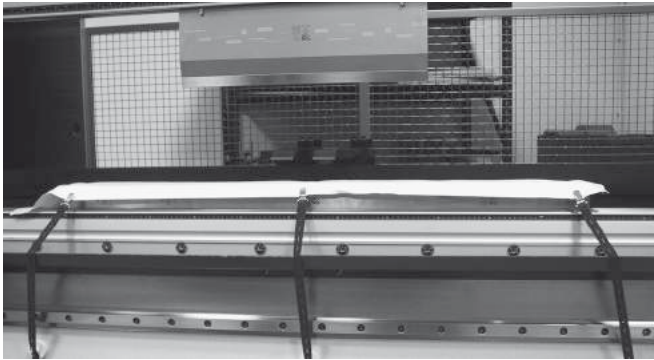

Set

Clamping set

Clamping system for protective foil/cloth K-003/K-004/K-005.
1 set consists of 6 magnets and 6 straps.

D(1+2)



Type	Length	Weight kg
D1	510 mm	1,2
D2	510 mm	0,6

Makes the crowning with Manual Clamping suitable for European Style bottom tools with a width of 60 mm. One set includes one bar of D1/D2.

4-WAY DIE CLAMP SET



Set	Weight kg
4-way die clamp set	1,5

Makes the crowning suitable for 4-ways dies with block size 2 3/4"; 3 1/4"; 3 3/4"; 4 1/4".
One set includes 8 clamps.

PRESS BRAKE PRODUCTIVITY WAX



Press Brake Productivity Wax is a spray that has been specially developed for cleaning, maintaining and protecting WILA tools.

Required press force at 90° air bending, force in t/m.

The charts below give the appropriate tonnage to air bend mild steel.

Bending force for other metals:

- Soft aluminum : Tons per unit length x 50%
- Aluminum alloys heat treated : Tons per unit length x 100%
- Stainless : Tons per unit length x 150%
- Bottoming : Tonnage requirements are three to five times greater than for air bending.

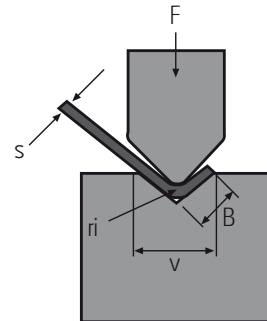

F = Tons per meter of workpiece
 s = Material thickness
 ri = Inside radius of formed part
 v = V-die opening
 B = Minimum flange

Metric

V (mm)	4	6	8	10	12	16	20	24	30	40	50	60	80	100	120	160
V (inch)	0.157*	0.236*	0.315*	0.394*	0.472*	0.630*	0.787*	0.945*	1.181*	1.575*	1.969*	2.362*	3.150*	3.937*	4.724*	6.299*
B (outside mm)	2.8	4.2	5.6	7	8.6	11.5	14.4	17	21	29	36	42.4	56.5	71	85	114
ri (mm)	0.6	1	1.2	1.5	1.8	2.4	3	3.6	4.5	6	7.5	9	12	15	18	24

Material Thickness
mm

0.5	4	2														
1		10	8	5.5	4.5											
1.2		16	12	9	7											
1.5			20	14	11	8	6									
2					22	15	11	9.5								
2.5						25	19	15	11							
3							28	22	17	12						
4								44	33	22.5	17					
5									55	37	29	22				
6										58	42	34				
8											83	65	45	35		
10												110	75	57	45	
12													116	85	68	
14														121	91	68
15														143	112	79
16														168	131	90
18															172	119
20															222	150
25																254

Inch

V (mm)	6.4	9.5	12.7	15.9	19.05	22.2	25.4	28.6	31.8*	38.1	50.8	63.5	80	100	120	160
V (inch)	0.250*	0.375*	0.500*	0.625*	0.750*	0.875*	1.000*	1.125*	1.250*	1.500*	2.000*	2.500*	3.150*	3.937*	4.724*	6.299*
B (outside inch)	0.167*	0.265*	0.354*	0.442*	0.530*	0.619*	0.707*	0.795*	0.866*	1.06*	1.414*	1.768*	2.224*	2.795*	3.346*	4.488*
ri (inch)	0.038*	0.056*	0.075*	0.094*	0.113*	0.131*	0.150*	0.169*	0.188*	0.225*	0.300*	0.375*	0.472*	0.591*	0.709*	0.945*

Material Thickness
Gauge Inches

20	0.036"	3.2	2.0														
18	0.048"	5.1	3.4	2.7	2.4												
16	0.060"		5.8	4.0	3.1	2.5											
14	0.075"			6.9	5.0	4.0	3.5										
12	0.105"					8.3	6.9	5.6									
11	0.120"						9.9	8.2	7.2	5.4							
10	0.135"						11.9	9.9	7.3	7.1	5.8						
3/16"	0.188"								14.3	14.2	12.2	7.5					
1/4"	0.250"										23.7	16.5	11.4				
5/16"	0.313"											27	19.7				
3/8"	0.375"											42.3	30.9	22.8	16.9		
7/16"	0.438"													32.2	24.3	19.4	
1/2"	0.500"														34.6	27.0	18.3
5/8"	0.625"															47.1	32.0
3/4"	0.750"															74.2	50.4
7/8"	0.875"																73.9
1"	1.000"																103.0

ALL SORTS OF INFORMATION

Mild steel

Rm≈42 KN/cm²
Rm≈55-60.000 PSI



Rm≈42 KN/cm²
Rm≈55-60.000 PSI



Thickness

Tonnage

D

Tonnage

D

mm	inches	t/m	US t/ft	mm	inches	t/m	US t/ft	mm	inches
0.6	.024	12	4.0	2.3	.091	20	6.7	1.3	.051
0.8	.031	16	5.4	2.3	.091	30	10.1	1.7	.067
1.0	.039	20	6.7	2.4	.095	30	10.1	2.2	.087
1.2	.047	24	8.1	3.0	.118	40	13.4	2.5	.098
1.5	.059	30	10.1	4.4	.173	50	16.8	3.5	.138
2.0	.079	40	13.6	5.1	.201	60	20.2	4.2	.165
2.5	.098	65	21.8	6.6	.260				
3.0	.118	90	30.2	8.2	.323				

Stainless steel

Rm≈70 KN/cm²
Rm≈100.000 PSI



Rm≈70 KN/cm²
Rm≈100.000 PSI



Thickness

Tonnage

D

Tonnage

D

mm	inches	t/m	US t/ft	mm	inches	t/m	US t/ft	mm	inches
0.6	.024	20	6.7	2.3	.091	35	11.8	1.3	.051
0.8	.031	27	9.0	2.3	.091	50	16.8	1.7	.067
1.0	.039	34	11.4	2.4	.095	50	16.8	2.2	.087
1.2	.047	40	13.5	3.0	.118	80	26.9	2.5	.098
1.5	.059	50	16.8	4.4	.173	85	28.6	3.5	.138
2.0	.079	90	30.3	5.1	.201	120	40.4	4.7	.185
2.5	.098	110	37.0	8.6	.339				
3.0	.118	125	42.0	10.4	.409				

INDUSTRY 4.0: FROM PRODUCT TO PROCESS

More and more companies in the press brake industry are encountering major changes in market demand. Customers are looking for smaller series, which often consist of more complex products. Tools need to be changed more frequently, which means valuable time is being lost. Faster set-up times and 'first time right' are becoming increasingly important in the drive to maintain productivity. How can Industry 4.0 help companies to remain competitive in this changing market?

Process control is becoming increasingly important. The lowest total cost of ownership (TCO) - and thus the strongest competitive position - can only be attained if the whole process is optimized. In Industry 4.0, machines, products and services are all part of the same data network, which means they can use each other's information to optimize the whole production process.

WILA's approach

WILA is ready for a future based on Industry 4.0. Data communication and data management play an important role in the development of all our new products and technologies. Examples of this include TIPS (Tooling Identification and Positioning System), which allows us to add intelligence to the tooling system, and the Tool Advisor, which allows us to offer online tooling advice to users.



Smart Tooling

By incorporating electronics into clamping systems and intelligence into tools (smart tooling), it is possible to clearly identify the location of specific tools in clamping and storage systems. Human errors can be eliminated because bending is only carried out if the tool set-up matches the program selected in the operating software. In automated environments, robots can, for example, use TIPS technology to always select the correct set-up and realize efficient tool changes. Other errors, like when tools shift slightly or are accidentally knocked out of position by the operator, can also be eliminated from the bending process because the model and position of all the tools is reported to the operating software.

Tool Advisor

The Tool Advisor is another specific example of Industry 4.0. WILA has compiled and digitalized the knowledge behind our tooling advice, which means it is also available online. The main advantage of this is that customers can receive advice about their tool selection 24/7. Tool selection is evaluated in real time based on compatibility, load-bearing capacity, and production capability. Price and delivery time immediately appear on screen and orders can be placed on the spot. This means customers are no longer restricted by business hours or the availability of WILA employees. Business can continue as normal after office hours, thus guaranteeing you the fastest possible quote, ordering, and delivery process.



THE COLD HARD TRUTH! CNC-DEEPHARDENING® VERSUS NITRIDE

Due to improvements in quality and durability, press brake tooling is no longer a perishable commodity. When properly cared for and used within the correct range of applications, today's precision ground and hardened press brake tooling can often provide an extremely long usable service life. That is not to say that it will simply last for ten years or more, but rather, it will provide performance that is the same or nearly the same as it did when it was brand new and right out of the box for that long or longer.

This is certainly not true of all press brake tooling. It is true however of high quality precision ground and hardened press brake tooling. As such, when purchasing tooling for a new press brake, today's press brake buyer is now more than ever making a long term decision. And as with any other long term business decision, you'll want to make the decision that will provide you with maximum productivity and the maximum return on your investment.



*Bottom tool with WILA's proprietary
CNC-Deephardenening® process applied.*

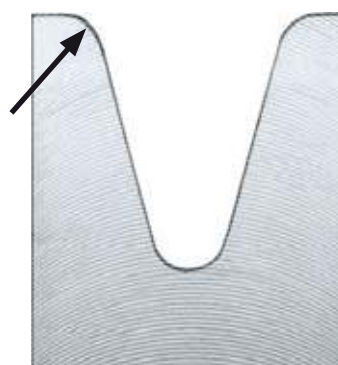

*Bottom tool with competitors Nitride
process applied.*

TERMS

Credit: WILA is entitled to conduct a creditworthiness check before an order is accepted.

Payment: Terms are based on individual agreements per customer or per items. Prices are in Euro EXW Lochem, The Netherlands.

Returns: Prior approval, a WILA RMA number and shipping instructions are required before any material is returned. A handling charge of 20% is made on all standard items returned, if received in original packaging and in as new condition. Special tooling cannot be returned.

Claims: WILA must be informed in advance by email or phone on all claims and deviations within 10 days of invoice date.

Our purchases and sales are subject to the "Orgalime - General conditions for the delivery of mechanical, electrical and electronic products", you can download these conditions via hyperlink www.wilatooling.com/disclaimer-and-conditions/.

DISCLAIMER

No part of this publication may be reproduced and/or published by means of printing, photocopying, microfilm or otherwise, without the prior written permission of WILA.

Although the data recorded in this publication were compiled by the author(s) with the utmost care, WILA accepts no liability whatsoever for any incomplete or inaccurate information which may nonetheless have been included. Our products are constantly improved, which means that the current model may differ from the examples given.

SAFETY WARNING

All WILA standard top tools include a safety device incorporated in the adaptation. New Standard Premium, New Standard Pro and American Style either have a Safety-Click®, E2M® or fixed (HD) Safety-Pins.

When using top tools and bottom tools on a press brake, a forming system is created which requires analysis to determine the appropriate safe guarding for operator safety and protection. The load ratings of all tooling should be analyzed for the application.

It is the user's responsibility to ensure that the point of operation is effective and all required safety requirements are met.

SERVICE AND SUPPORT

Service and support is a major priority at WILA. Because we want our customers to receive the best possible service, you can contact us by sending an e-mail to service.eu@wilatooling.com or by phoning +31 (0) 573 28 98 50. We will be able to further improve our support if send us the WILA serial number, an accurate description and photos of the issue in question.

SUPPLY OF COMPONENTS

We are able to supply all the original WILA replacement and consumable parts you will require. And we can normally deliver these from stock or very quickly in order to meet your requirements. Naturally, our employees will be pleased to assist you.

USER MANUALS

WILA will supply a 'Quick Start guide' with each product you purchase, which features instructions for using all our products. This 'Quick Start guide' can also be downloaded from our website in various languages. Our products are also accompanied by an English user manual, which provides detailed information about the most effective way to use our products. You can request these user manuals by sending an e-mail to service.eu@wilatooling.com or you can download them from our brand portal.

GUARANTEE

Our deliveries are subject to the "General conditions for supplying mechanical, electrical and electronic products", also known as Orgalime.

If you have a question which does not relate to Service, please call +31 (0)573 28 98 50 or contact:

Quotes: quotes.eu@wilatooling.com

Orders: orders.eu@wilatooling.com

Transport: transport.eu@wilatooling.com

WILA. THE PRESS BRAKE PRODUCTIVITY PEOPLE.

WILA fully concentrates on the development of products and solutions to optimize the productivity of your press brake. WILA has been producing clamping and crowning systems as well as tools and accessories to improve set-up times and increase the precision of your press brake for decades. Through close cooperation with the world's leading press brake manufacturers, an extensive and competent distribution network, in-house development, sales and production, WILA is the right partner to fulfill your needs.

WILA B.V.

P.O. box 60

NL-7240 AB Lochem

The Netherlands

Phone: +31 (0)573 28 98 00

Phone sales: +31 (0)573 28 98 50

E-mail: info.eu@wilatooling.com



ORDER OUR TOOLING ONLINE

Get prices, delivery times and place quotes and orders in just a few clicks using Webshop.

www.wilatooling.com

www.wilatooling.com

 **WILA**
THE PRESS BRAKE PRODUCTIVITY PEOPLE